

# Product Catalogue

**Boston  
Scientific**

Advancing science for life™

Produktkatalog – Catalogue Produits  
Catálogo de Productos – Catalogo dei Prodotti

*Guidewires*



*Dilatation Products*



*Stone Retrieval Devices*



*Ureteral Stents*



*Ureteral Catheters*



*Nephrostomy Products*



## Urology and Women's Health



*Lithotripsy Products*



*BPH/Oncology*



*Procedure Accessories*



*Pelvic Floor Products*



*Stress Urinary  
Incontinence Products*

# Table of Contents Endourology, Female Incontinence and Pelvic Floor Reconstruction

## GUIDEWIRES

### SENSOR™ GUIDEWIRES ..... 5

Sensor™ Dual-Flex PTFE-Nitinol Guidewires  
with Hydrophilic Tip  
(10cm Flexible Proximal End)

Sensor™ PTFE-Nitinol Guidewires  
with Hydrophilic Tip

### HYDROPHILIC GUIDEWIRES ..... 5

ZIPwire™ Hydrophilic Guidewires

### ZEBRA™ UROLOGICAL GUIDEWIRES ... 6

Zebra™ Urological Guidewires

### PTFE COATED GUIDEWIRES ..... 6-7

PTFE Coated Guidewires (Fixed Core)

PTFE Coated Guidewires  
(Fixed Core, Stiff Bodied)

PTFE Coated Guidewires (Moveable Core)

Amplatz Super Stiff™ PTFE Coated Guidewires

### LUBRIGLIDE™ COATED GUIDEWIRES . 7

Standard Lubriglide™ Coated Guidewires  
(Fixed Core)

Standard Lubriglide™ Coated Guidewires  
(Fixed Core, Stiff Bodied)

Standard Lubriglide™ Coated Guidewires (Moveable  
Core)

### GUIDEWIRE ACCESSORIES ..... 8

Guidewire Torque Vise

## PROCEDURAL SHEATHS

### URETERAL ACCESS SHEATHS AND SHEATH SETS ..... 11

Navigator™ HD Ureteral Access Sheath

Navigator™ Ureteral Access Sheath Sets

## DILATATION PRODUCTS

### URETERAL BALLOON DILATATION CATHETERS ..... 13-14

UroMax Ultra™ High Pressure Balloon  
Dilatation Catheters

UroMax Ultra™ High Pressure Balloon  
Dilatation Catheters (Kits)

Passport™ Balloon Dilatation Catheters (Kits)

Passport™ Balloon Dilatation Catheters

### INFLATION DEVICES ..... 14

Encore™ 26 Inflator

### URETERAL DILATORS ..... 15

Nottingham™ One-Step Tapered Dilators  
with HydroPlus™ Coating

Ureteral Dilator with HydroPlus™ Coating  
and Procedural Sheath Set

Ureteral Dilatation Set with HydroPlus™ Coating

Ureteral Dilators with HydroPlus™ Coating

## LITHOTRIPSY PRODUCTS

### LASER SYSTEMS ..... 16

AccuMax™ Single-Use Holmium Laser Fiber

Flexiva™ High Power Single-Use Laser Fiber

AccuTrac™ Single-Use Holmium Laser Fiber

Flexiva™ TracTip High Power Single-Use  
Laser Fiber

## STONE RETRIEVAL DEVICES

### ANTIRETROPULSION DEVICES ..... 17

BackStop™ Stone Antiretropulsion Device

Stone Cone™ Nitinol Urological Retrieval Coils

### NITINOL RETRIEVAL DEVICES .. 17-18

OptiFlex™ Nitinol Stone Retrieval Basket

Escape™ Nitinol Stone Retrieval Basket

Graspit™ Nitinol Stone Retrieval Forceps

Zero Tip™ Nitinol Stone Retrieval Baskets

### STAINLESS RETRIEVAL DEVICES 19-21

Gemini™ Paired Wire Helical Baskets

Bagley™ Helical Baskets

Segura Hemisphere™ Stone Retrieval Baskets

Tricep™ Hooked-Prong Grasping Forceps

Leslie Parachute™ Multi-Wire Stone  
Sweeping Devices

LithoCatch™ Immobilization Device

# Table of Contents

Endourology, Female Incontinence and Pelvic Floor Reconstruction

## URETERAL STENTS

### STENT STORE .....23–40

- Polaris™ Loop Ureteral Stent (Dual Durometer Percuflex™ Material with HydroPlus™ Coating)
- Polaris™ Ultra Ureteral Stent (Dual Durometer Percuflex™ Material with HydroPlus™ Coating)
- Percuflex Plus™ Ureteral Stent (with HydroPlus™ Coating)
- Percuflex Plus™ Ureteral Stent (with HydroPlus™ Coating and Braided Retrieval Line)
- Contour™ Ureteral Stent (with HydroPlus™ Coating) – *A Softer Percuflex Material Stent*
- Contour Ureteral Stent (with HydroPlus™ Coating and Braided Retrieval Line)
- Percuflex™ Ureteral Stent
- Mardis™ Soft Ureteral Stent (with HydroPlus™ Coating)
- Contour VL™ Ureteral Stent (Percuflex Material with HydroPlus™ Coating)
- Stretch™ VL Flexima™ Ureteral Stent Set (with HydroPlus™ Coating)

## URETERAL STENTS AND SETS....41–42

- Contour™ Injection Stents (with HydroPlus™ Coating) – *A Percuflex Material Stent*
- Contour™ VL Injection Stent Set (with HydroPlus™ Coating) – *A Percuflex Material Stent*
- Retromax™ Plus (Endopyelotomy Stents with HydroPlus™ Coating)
- Percuflex™ Urinary Diversion Stent Set (Open Tip Configuration)
- Percuflex™ Urinary Diversion Stent Set (Closed Tip Configuration)

## STENT ACCESSORIES .....42

- Ureteral Stent Positioner

## URETERAL CATHETERS

### TORQUEABLE CATHETERS.....44

- Dual Lumen™ Ureteral Catheter
- Imager™ II Catheters

### URETERAL CATHETERS .....45–47

- Flexima™ Ureteral Catheters
- Flexima Ureteral Catheters (Sets with .035“ PTFE Bentson Tip Guidewire)
- Axxcess™ 6 French Ureteral Catheter
- C-Flex™ Flexible Tip Open End Ureteral Catheters (Sets)
- C-Flex™ Firm Open End Ureteral Catheters (Sets)
- C-Flex™ Firm Stamey Open Tip Ureteral Catheters (Sets)
- C-Flex™ Ureteral Pigtail Catheters

## NEPHROSTOMY PRODUCTS

### PERCUTANEOUS KITS.....49

- Lingeman Percutaneous Tract Kit with NephroMax™ High Pressure Nephrostomy Balloon Dilatation Catheter
- Percutaneous Tract Kit with NephroMax High Pressure Balloon Dilatation Catheter
- Percutaneous Access Set (without Balloon or Amplatz Dilators)
- Percutaneous Access Set – Pigtail Catheter
- Percutaneous Access Set – Malecot Catheter

### JINRO™ PERCUTANEOUS KITS..... 50

- Percutaneous Kit – Pigtail Design
- Percutaneous Kit – Replacement Kits
- Percutaneous Kit – Flexima™ Catheter Pigtail Design

### BALLOON DILATION CATHETERS..51

- NephroMax™ High Pressure Nephrostomy Balloon Dilatation Catheter
- NephroMax™ High Pressure Nephrostomy Balloon Dilatation Catheter (Kit)

### INFLATION DEVICES ..... 51

- Encore™ 26 Inflator

### DILATORS AND SHEATHS.....52–53

- Clear Renal Sheath
- Amplatz Type Renal Dilator/Sheath Set
- Amplatz Type Graduated Renal Dilator Set
- Amplatz Type Renal Dilators (Individual Components)
- Amplatz Type Renal Sheath (Set)
- Amplatz Type Renal Sheaths (Individual Components)
- 8/10 Dilator/Sheath Set

### TORQUEABLE CATHETERS.....54

- Imager™ II Catheters

### OCCLUSION BALLOON CATHETERS.....55

- Occluder™ Occlusion Balloon Catheters

### ACCESS DEVICES ..... 56

- Access Needles

### DRAINAGE CATHETERS.....57–60

- Malecot™ Nephrostomy Catheters
- Re-Entry™ Malecot Nephrostomy Catheters
- Percuflex™ Locking Loop All Purpose Drainage Catheter with Fader Tip™
- Percuflex™ Locking Loop Nephrostomy Catheters with Fader Tip
- Percuflex™ Locking Loop Nephrostomy Catheters with Fader Tip™ (Kits)
- Percuflex™ Combination Stent/Nephrostomy Catheter
- Percuflex™ Locking Loop Nephrostomy Catheters
- Percutaneous Nephrostomy Sets – Pigtail Design
- Percutaneous Nephrostomy Catheter Set – Malecot Design

## BIOPSY DEVICES

### FORCEPS.....63

- Piranha™ 3Fr (1mm) Ureteroscopic Biopsy Forceps

## SUTURING DEVICES

### SUTURE CAPTURING DEVICES.....63

- Capio™ RP Suturing Device for Radical Prostatectomy

## ELECTROSURGICAL PRODUCTS

### RESECTION DEVICES FOR USE WITH VARIOUS RESECTOSCOPES.....65

- Compatible for Use with Storz Brand Single Stem Resectoscope
- Compatible for Use with Storz Brand Double Stem Resectoscope
- Compatible for Use with Olympus Brand OES™ Resectoscope
- Compatible for Use with Olympus Brand OES-Pro™ Series Resectoscope
- Compatible for Use with Wolf Brand Resectoscope

# Table of Contents Endourology, Female Incontinence and Pelvic Floor Reconstruction

## PROCEDURE ACCESSORIES

### INFLATION DEVICES .....67

Encore™ 26 Inflator

### IRRIGATION, EVACUATION AND

### RESECTION ACCESSORIES .....67-68

Urovac™ Bladder Evacuator

SAPS™ Single Action Pumping System

SAPS™ CF Continuous Flow Single Action Pumping System

### OTHER.....69

UroLok™ II Scope Adaptor

Gateway™ Advantage Y Adaptor

Connecting Tubes for Drainage Bag

Ureteral Catheter Connectors

Drainage Bag Connectors

## PELVIC FLOOR PRODUCTS

### MID-URETHRAL SLING SYSTEMS.....71-72

Advantage™ System (Transvaginal)

Advantage Fir™ System (Transvaginal)

Lynx™ System (Suprapubic)

**NEW** Obtryx™ II Transobturator Mid-Urethral Sling System

Obtryx™ System Halo or Curved (Transobturator)

Solyx™ SIS System

### SUTURING SYSTEMS .....73

**NEW** Capio™ SLIM Suture Capturing Devices

Capio™ Suture Capturing Devices

Capio™ Sutures

### RECONSTRUCTION GRAFTS.....74

Xenform™ Tissue Repair Matrix

Polyform™ Synthetic Mesh

### RECONSTRUCTION KITS.....74

Pinnacle™ Pelvic Floor Repair Kits

Uphold™ Lite Vaginal Support System

**NEW** Upsylon Y-Mesh and Colpassist Vaginal Positioning Device Kit

### ENDOMETRIAL ABLATION

### SYSTEM.....75

Genesys HTA™ System

Genesys HTA™ ProCerva™ Procedure Set

HTA ProCerva™ Procedure Set

HTA™ System Hysteroscope Adaptors (for both Genesys HTA System and HTA System)

### PRODUCT CODE INDEX..... 77-96

### PRODUCT INDEX..... 98-99

## GUIDEWIRES

### SENSOR™ GUIDEWIRES

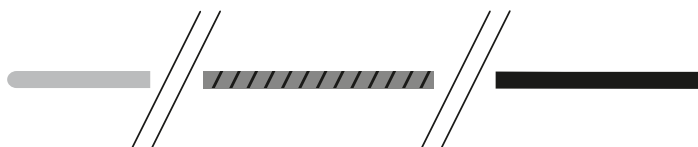

#### ■ Sensor™ Dual-Flex PTFE-Nitinol Guidewires with Hydrophilic Tip (10cm Flexible Proximal End)

Order Number	Diameter		Length (cm)	Tip Design	
	(in)	(mm)		(Shape)	(Style)
M006 <b>670308</b> 1	.035	0.89	150	Straight	3cm Flexible
M006 <b>670301</b> 1	.035	0.89	150	Angled	3cm Flexible
M006 <b>670312</b> 1	.038	0.97	150	Straight	3cm Flexible
M006 <b>670302</b> 1	.038	0.97	150	Angled	3cm Flexible

Packaged Five (5) Per Box

#### ■ Sensor™ PTFE-Nitinol Guidewires with Hydrophilic Tip

Order Number	Diameter		Length (cm)	Tip Design	
	(in)	(mm)		(Shape)	(Style)
M006 <b>670305</b> 1	.035	0.89	150	Straight	3cm Flexible
M006 <b>670306</b> 1	.035	0.89	150	Angled	3cm Flexible
M006 <b>670309</b> 1	.038	0.97	150	Straight	3cm Flexible
M006 <b>670310</b> 1	.038	0.97	150	Angled	3cm Flexible

Packaged Five (5) Per Box

### HYDROPHILIC GUIDEWIRES

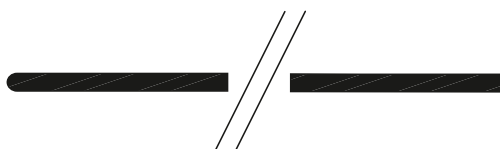

#### ■ ZIPwire™ Hydrophilic Guidewires

Order Number	Diameter		Length (cm)	Tip Shape	Shaft Stiffness
	(in)	(mm)			
M006 <b>630201B</b> 1	.025	0.64	150	Straight	Regular
M006 <b>630216B</b> 1	.025	0.64	150	Straight	Stiff
M006 <b>630205B</b> 1	.035	0.89	150	Straight	Regular
M006 <b>630206B</b> 1	.035	0.89	150	Angled	Regular
M006 <b>630222B</b> 1	.035	0.89	150	Straight	Stiff
M006 <b>630223B</b> 1	.035	0.89	150	Angled	Stiff
M006 <b>630208B</b> 1	.038	0.97	150	Straight	Regular
M006 <b>630209B</b> 1	.038	0.97	150	Angled	Regular
M006 <b>630225B</b> 1	.038	0.97	150	Straight	Stiff

Packaged Five (5) Per Box

# GUIDEWIRES

## ZEBRA™ UROLOGICAL GUIDEWIRES

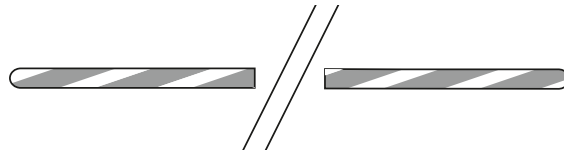

### Zebra™ Urological Guidewires

Order Number	Diameter		Length (cm)	Tip Design	
	(in)	(mm)		(Shape)	(Style)
M0066701081	.025	0.64	150	Straight	3cm Flexible
M0066701091	.025	0.64	150	Angled	3cm Flexible
M0066701101	.032	0.81	150	Straight	3cm Flexible
M0066701121	.035	0.89	150	Straight	3cm Flexible
M0066701131	.035	0.89	150	Angled	3cm Flexible
M0066701141	.038	0.97	150	Straight	3cm Flexible
M0066701151	.038	0.97	150	Angled	3cm Flexible

Supplied with Torque Vise

Packaged Five (5) Per Box

## PTFE COATED GUIDEWIRES

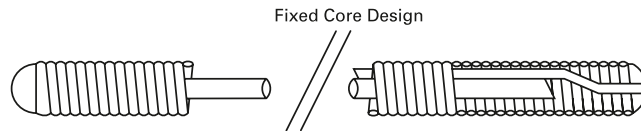

### PTFE Coated Guidewires (Fixed Core)

Order Number	Diameter		Length (cm)	Tip Design	
	(in)	(mm)		(Shape)	(Style)
M0066201070	.025	0.64	150	Straight	3cm Flexible
M0066201200	.035	0.89	150	Straight	3cm Flexible
M0066201250	.035	0.89	150	Straight	15cm Flexible; Bentson-Type
M0066201000	.038	0.97	150	Straight	3cm Flexible
M0066201050	.038	0.97	150	Straight	15cm Flexible; Bentson-Type

### PTFE Coated Guidewires (Fixed Core, Stiff Bodied)

Order Number	Diameter		Length (cm)	Tip Design	
	(in)	(mm)		(Shape)	(Style)
M0066201080	.025	0.64	150	Straight	3cm Flexible
M0066201100	.035	0.89	150	Straight	3cm Flexible
M0066201110	.035	0.89	150	3mm "J"	
M0066201010	.038	0.97	150	Straight	3cm Flexible
M0066201020	.038	0.97	150	3mm "J"	

## GUIDEWIRES

### PTFE COATED GUIDEWIRES (Continued)

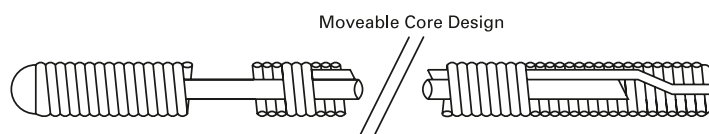

#### ■ PTFE Coated Guidewires (Moveable Core)

Order Number	Diameter		Length (cm)	Tip Design	
	(in)	(mm)		(Shape)	(Style)
M0066201300	.035	0.89	150	Straight	
M0066201210	.035	0.89	150	3mm "J"	
M0066201030	.038	0.97	150	Straight	
M0066201220	.038	0.97	150	3mm "J"	

#### ■ Amplatz Super Stiff™ PTFE Coated Guidewires

Order Number	Diameter		Length (cm)	Tip Design	
	(in)	(mm)		(Shape)	(Style)
M0066401041	.035	0.89	145	Straight	7cm Flexible, Bentson-Type
M0066401051	.035	0.89	145	3mm "J"	v182.00/bx
M0066401081	.035	0.89	145	Straight	3.5cm Flexible
M0066401061	.038	0.97	145	Straight	6cm Flexible, Bentson-Type
M0066401071	.038	0.97	145	3mm "J"	
M0066401091	.038	0.97	145	Straight	3.5cm Flexible

Packaged Five (5) Per Box

## LUBRIGLIDE™ COATED GUIDEWIRES

#### ■ Standard Lubriglide™ Coated Guidewires (Fixed Core)

Order Number	Diameter		Length (cm)	Tip Design	
	(in)	(mm)		(Shape)	(Style)
M0066001060	.032	0.81	150	Straight	18cm Coil with 3cm Flexible; Lunderquist-Type
M0066001200	.035	0.89	150	Straight	3cm Flexible
M0066001250	.035	0.89	150	Straight	3cm Flexible
M0066001050	.038	0.97	150	Straight	15cm Flexible; Bentson-Type

#### ■ Standard Lubriglide™ Coated Guidewires (Fixed Core, Stiff Bodied)

Order Number	Diameter		Length (cm)	Tip Design	
	(in)	(mm)		(Shape)	(Style)
M0066001020	.038	0.97	150	Straight	3cm Flexible

#### ■ Standard Lubriglide™ Coated Guidewires (Moveable Core)

Order Number	Diameter		Length (cm)	Tip Design	
	(in)	(mm)		(Shape)	(Style)
M0066001300	.035	0.89	150	Straight	
M0066001030	.038	0.97	150	Straight	



# GUIDEWIRES

## GUIDEWIRE ACCESSORIES

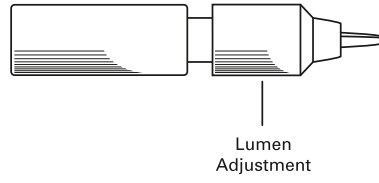

### ■ Guidewire Torque Vise

---

Order Number	Description
M0067301301	Torque Vise Steerable Handle

---

Packaged Twelve (12) Per Box





# PROCEDURAL SHEATHS

## URETERAL ACCESS SHEATHS AND SHEATH SETS

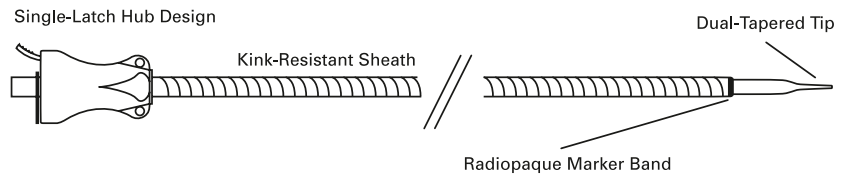

### **NEW** ■ Navigator™ HD Ureteral Access Sheath

Order Number	Description
M0062502210	11/13Fr/3.67/4.33 mm x 28 cm
M0062502220	11/13Fr/3.67/4.33 mm x 36 cm
M0062502230	11/13Fr/3.67/4.33 mm x 46 cm
M0062502240	12/14Fr/4/4.67 mm x 28 cm
M0062502250	12/14Fr/4/4.67 mm x 36 cm
M0062502260	12/14Fr/4/4.67 mm x 46 cm
M0062502270	13/15Fr/4.33/5 mm x 28 cm
M0062502280	13/15Fr/4.33/5 mm x 36 cm
M0062502290	13/15Fr/4.33/5 mm x 46 cm

### ■ Navigator™ Ureteral Access Sheath Sets

Order Number	Description
M0062502000	11/13Fr/3.7/4.3 mm x 28 cm
M0062502020	11/13Fr/3.7/4.3 mm x 36 cm
M0062502040	11/13Fr/3.7/4.3 mm x 46 cm
M0062502060	13/15Fr/4.3/5.0 mm x 28 cm
M0062502080	13/15Fr/4.3/5.0 mm x 36 cm
M0062502100	13/15Fr/4.3/5.0 mm x 46 cm
M0062502031*	11/13Fr/3.7/4.3 mm x 36 cm

\*Packaged Five (5) Per Box



# DILATATION PRODUCTS

## URETERAL BALLOON DILATATION CATHETERS

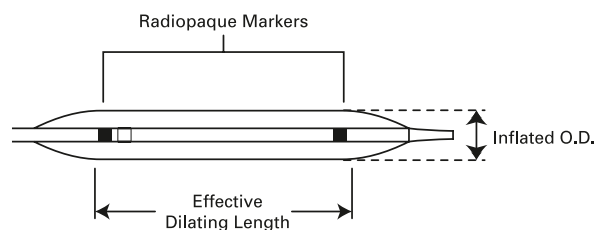

### ■ UroMax Ultra™ Balloon Dilatation Catheters

Order Number	Balloon Inflated O.D.		Balloon Length (cm)	Catheter Size		Usable Length (cm)	Recommended Guidewire	
	(Fr)	(mm)		(Fr)	(mm)		(in)	(mm)
M0062251000	12	4.0	4	5.8	1.9	75	.038	0.97
M0062251010	15	5.0	4	5.8	1.9	75	.038	0.97
M0062251020	18	6.0	4	5.8	1.9	75	.038	0.97
M0062251030	21	7.0	4	5.8	1.9	75	.038	0.97
M0062251040	24	8.0	4	5.8	1.9	75	.038	0.97
M0062251050	30	10.0	4	5.8	1.9	75	.038	0.97
M0062251060	12	4.0	6	5.8	1.9	75	.038	0.97
M0062251070	15	5.0	6	5.8	1.9	75	.038	0.97
M0062251080	18	6.0	6	5.8	1.9	75	.038	0.97
M0062251090	21	7.0	6	5.8	1.9	75	.038	0.97
M0062251100	24	8.0	8	5.8	1.9	75	.038	0.97
M0062251110	30	10.0	8	5.8	1.9	75	.038	0.97
M0062251150	12	4.0	10	5.8	1.9	75	.038	0.97
M0062251160	15	5.0	10	5.8	1.9	75	.038	0.97
M0062251170	18	6.0	10	5.8	1.9	75	.038	0.97
M0062251180	21	7.0	10	5.8	1.9	75	.038	0.97

### ■ UroMax Ultra™ Balloon Dilatation Catheters (Kits)

Order Number	Balloon Inflated O.D.		Balloon Length (cm)	Catheter Size		Usable Length (cm)	Recommended Guidewire	
	(Fr)	(mm)		(Fr)	(mm)		(in)	(mm)
M0062251200	12	4.0	4	5.8	1.9	75	.038	0.97
M0062251210	15	5.0	4	5.8	1.9	75	.038	0.97
M0062251220	18	6.0	4	5.8	1.9	75	.038	0.97
M0062251230	21	7.0	4	5.8	1.9	75	.038	0.97
M0062251240	24	8.0	4	5.8	1.9	75	.038	0.97
M0062251250	30	10.0	4	5.8	1.9	75	.038	0.97
M0062251260	12	4.0	6	5.8	1.9	75	.038	0.97
M0062251270	15	5.0	6	5.8	1.9	75	.038	0.97
M0062251280	18	6.0	6	5.8	1.9	75	.038	0.97
M0062251290	21	7.0	6	5.8	1.9	75	.038	0.97
M0062251300	24	8.0	8	5.8	1.9	75	.038	0.97
M0062251310	30	10.0	8	5.8	1.9	75	.038	0.97
M0062251350	12	4.0	10	5.8	1.9	75	.038	0.97
M0062251360	15	5.0	10	5.8	1.9	75	.038	0.97
M0062251370	18	6.0	10	5.8	1.9	75	.038	0.97
M0062251380	21	7.0	10	5.8	1.9	75	.038	0.97

Kit Includes: UroMax Ultra™ High Pressure Balloon Dilatation Catheter, Encore™ 26 Inflator

## DILATATION PRODUCTS

### URETERAL BALLOON DILATATION CATHETERS (Continued)

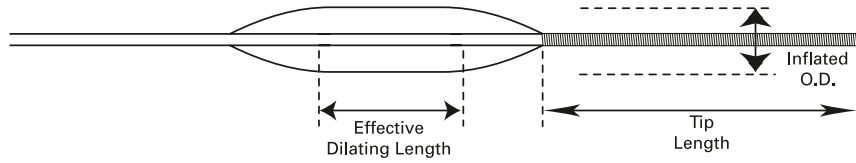

#### Passport™ Balloon Dilatation Catheter (Kits) contains LATEX

Order Number	Balloon Inflated O.D.		Balloon Length (cm)	Tip Length (cm)	Shaft Diameter		Usable Length (cm)	Minimum Working Channel	
	(Fr)	(mm)			(Fr)	(mm)		(Fr)	(mm)
M0062181200	12	4.0	2	2	3	1.0	150	3.4	1.1
M0062181210	12	4.0	2	4	3	1.0	150	3.4	1.1
M0062181300	12	4.0	4	2	3	1.0	150	3.4	1.1
M0062181310	12	4.0	4	4	3	1.0	150	3.4	1.1

Kit Includes: Passport Balloon Dilatation Catheter, Encore™ 26 Inflator

#### Passport™ Balloon Dilatation Catheter contains LATEX

Order Number	Balloon Inflated O.D.		Balloon Length (cm)	Tip Length (cm)	Shaft Diameter		Usable Length (cm)	Minimum Working Channel	
	(Fr)	(mm)			(Fr)	(mm)		(Fr)	(mm)
M0062181000	12	4.0	2	2	3	1.0	150	3.4	1.1
M0062181010	12	4.0	2	4	3	1.0	150	3.4	1.1
M0062181100	12	4.0	4	2	3	1.0	150	3.4	1.1
M0062181110	12	4.0	4	4	3	1.0	150	3.4	1.1

## INFLATION DEVICES

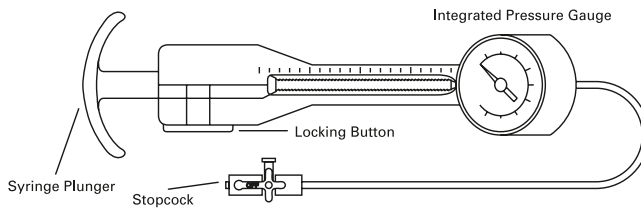

#### Encore™ 26 Inflator

Order Number	Description
M0067101131*	20ml Encore 26 Inflator with Pressure Gauge
M0067101140	20ml Encore 26 Inflator with Pressure Gauge

\*Packaged Five (5) Per Box

# DILATATION PRODUCTS

## URETERAL DILATORS

### ■ Nottingham™ One-Step Tapered Dilators with HydroPlus™ Coating

Order Number	Taper Size From/To (Fr) (mm)		Taper Length (cm)	Usable Length (cm)
M0062301000	6/10	2.0/3.3	4	70
M0062301010	6/12	2.0/4.0	4	70
M0062301100	10/16	3.3/5.3	4	70
M0062301150	12/18	4.0/6.0	4	70

### ■ Ureteral Dilator with HydroPlus™ Coating and Procedural Sheath Set

Order Number	Description
M0062501000	Ureteral Dilators and Procedural Sheath Set
Set Includes: One 6Fr/2.0mm, 8Fr/2.7mm, 10Fr/3.3mm, 12Fr/4.0mm and 14Fr/4.7mm C-Flex™ Radiopaque Dilator with HydroPlus™ Coating; One 16Fr/5.3mm O.D., 14Fr/4.7mm I.D. x 37.5cm Length Radiopaque PTFE Procedural Sheath; .038in/0.97mm PTFE Coated Guidewire	

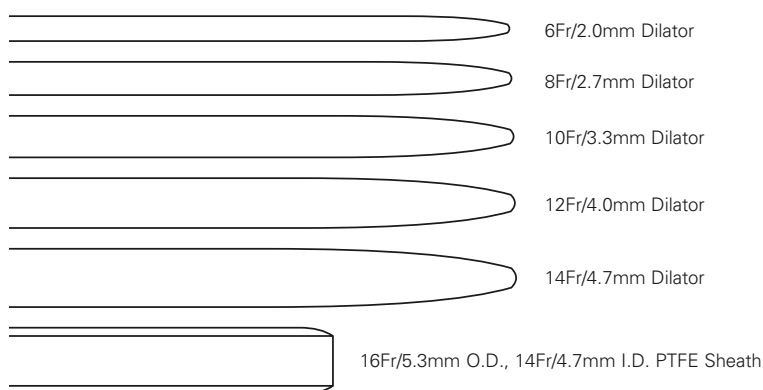

### ■ Ureteral Dilatation Set with HydroPlus™ Coating

Order Number	Description
M0062401000	Ureteral Dilatation Set
Set Includes: One 6Fr/2.0mm, 8Fr/2.7mm, 10Fr/3.3mm, 12Fr/4.0mm, 14Fr/4.7mm and 16Fr/5.3mm C-Flex Radiopaque Dilator with HydroPlus Coating and .038in/0.97mm PTFE Coated Guidewire	

### ■ Ureteral Dilators with HydroPlus™ Coating

Order Number	O.D. Size (Fr) (mm)		Usable Length (cm)
M0062401100	6	2.0	70
M0062401110	8	2.7	70
M0062401120	10	3.3	70
M0062401130	12	4.0	70
M0062401140	14	4.7	70
M0062401150	16	5.3	70



# LITHOTRIPSY PRODUCTS

## LASER SYSTEMS

### ■ AccuMax™ Single-Use Holmium Laser Fiber

For use with non Lumenis brand Laser Systems with SMA-905 connectors

Order Number	Description
M0068404010	AccuMax 200 Single-Use Holmium Laser Fiber
M0068404020	AccuMax 365 Single-Use Holmium Laser Fiber
M0068404030	AccuMax 550 Single-Use Holmium Laser Fiber
M0068404040	AccuMax 1000 Single-Use Holmium Laser Fiber
M0068404012	AccuMax 200 Single-Use Holmium Laser Fiber (5/bx)
M0068404022	AccuMax 365 Single-Use Holmium Laser Fiber (5/bx)
M0068404032	AccuMax 550 Single-Use Holmium Laser Fiber (5/bx)
M0068404042	AccuMax 1000 Single-Use Holmium Laser Fiber (5/bx)

### ■ Flexiva™ High Power Single-Use Laser Fiber

For use with Lumenis brand Laser Systems with SMA-905 connectors

Order Number	Description
M0068403910	Flexiva 200 High Power Single-Use Laser Fiber
M0068403920	Flexiva 365 High Power Single-Use Laser Fiber
M0068403930	Flexiva 550 High Power Single-Use Laser Fiber
M0068403940	Flexiva 1000 High Power Single-Use Laser Fiber
M0068403911	Flexiva 200 High Power Single-Use Laser Fiber (5/bx)
M0068403921	Flexiva 365 High Power Single-Use Laser Fiber (5/bx)
M0068403931	Flexiva 550 High Power Single-Use Laser Fiber (5/bx)
M0068403941	Flexiva 1000 High Power Single-Use Laser Fiber (5/bx)

### ■ AccuTrac™ Single-Use Holmium Laser Fiber

For use with non Lumenis brand Laser Systems with SMA-905 connectors

Order Number	Description
M0068404110	AccuTrac 200 Single-Use Holmium Laser Fiber
M0068404112	AccuTrac 200 Single-Use Holmium Laser Fiber (5/bx)

### ■ Flexiva™ TracTip High Power Single-Use Laser Fiber

For use with Lumenis brand Laser Systems with SMA-905 connectors

Order Number	Description
M0068403960	Flexiva TracTip 200 High Power Single-Use Laser Fiber
M0068403961	Flexiva TracTip 200 High Power Single-Use Laser Fiber (5/bx)

# STONE RETRIEVAL DEVICES

## ANTIRETROPULSION DEVICES

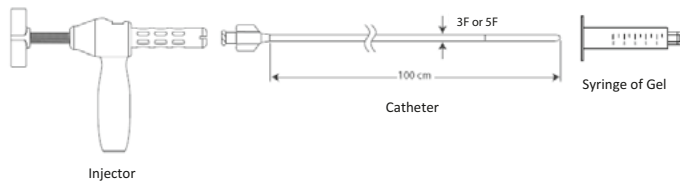

### ■ BACKSTOP™ STONE ANTIRETROPULSION DEVICE

Order Number	Description	Sheath O.D. (Fr) (mm)
<b>Disposable Components</b>		
M0063909000	BackStop Clear Gel x 3Fr Catheter	3 1.0
M0063909010	BackStop Clear Gel x 5Fr Catheter	5 1.67
<b>Reusable Components</b>		
M0063909040	BackStop Injector	
M0063909050	BackStop Replacement Sleeve	

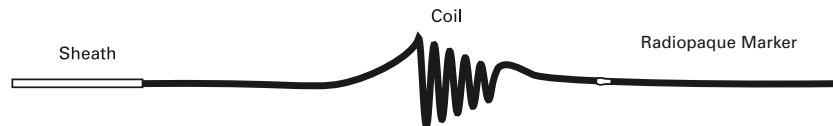

### ■ Stone Cone™ Nitinol Urological Retrieval Coils

Order Number	Description	Sheath O.D. (Fr) (mm)	Working Length (cm)	O.D. (mm)	Sheath Material
M0063903100	Nitinol Retrieval Coil	3 1.0	115	7	PTFE
M0063903200	Nitinol Retrieval Coil	3 1.0	115	10	PTFE

## NITINOL RETRIEVAL DEVICES



### ■ OptiFlex™ Nitinol Stone Retrieval Basket

Order Number	Description	Sheath O.D. (Fr) (mm)	Working Length (cm)	Basket O.D. (mm)
M0063903000	OptiFlex Nitinol Stone Retrieval Basket	1.3 0.43	90	11
M0063903010	OptiFlex Nitinol Stone Retrieval Basket	1.3 0.43	120	11

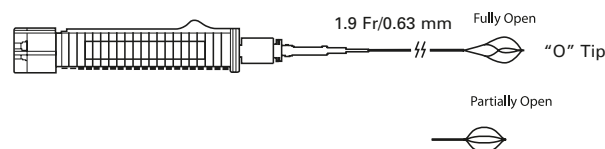

### ■ Escape™ Nitinol Stone Retrieval Basket

Order Number	Description	Sheath O.D. (Fr) (mm)	Working Length (cm)	Basket O.D. (mm)
M0063902000	Escape Nitinol Stone Retrieval Basket	1.9 0.63	90	11–15
M0063902010	Escape Nitinol Stone Retrieval Basket	1.9 0.63	120	11–15

Includes: y Adaptor

# STONE RETRIEVAL DEVICES

## NITINOL RETRIEVAL DEVICES (Continued)

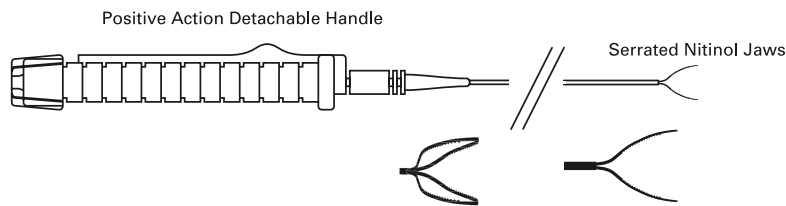

### ■ Graspit™ Nitinol Stone Retrieval Forceps

Order Number	Description	Sheath O.D. (Fr)	Sheath O.D. (mm)	Working Length (cm)	Basket O.D. (mm)	Sheath Material
M0063204000	Nitinol 2-Prong Forceps	2.6	0.87	90	8	Polyimide/PTFE
M0063204010	Nitinol 2-Prong Forceps	2.6	0.87	120	8	Polyimide/PTFE
M0063204020	Nitinol 2-Prong Forceps	3.3	1.1	90	10	Polyimide/PTFE
M0063204030	Nitinol 2-Prong Forceps	3.3	1.1	120	10	Polyimide/PTFE

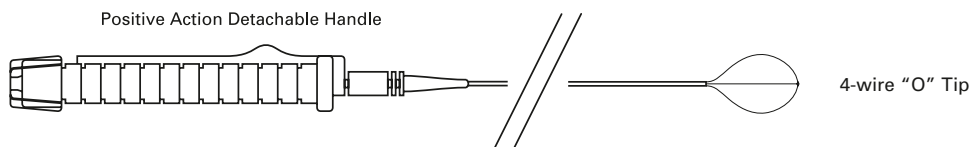

### ■ Zero Tip™ Nitinol Stone Retrieval Baskets

Order Number	Description	Sheath O.D. (Fr)	Sheath O.D. (mm)	Working Length (cm)	Basket O.D. (mm)	Sheath Material
M0063901040	Nitinol Zero Tip 4 Wire Basket	1.9	0.63	90	12	Polyimide/PTFE
M0063901050	Nitinol Zero Tip 4 Wire Basket	1.9	0.63	120	12	Polyimide/PTFE
M0063901000	Nitinol Zero Tip 4 Wire Basket	2.4	0.8	90	12	Polyimide/PTFE
M0063901010	Nitinol Zero Tip 4 Wire Basket	2.4	0.8	120	12	Polyimide/PTFE
M0063901020	Nitinol Zero Tip 4 Wire Basket	3.0	1.0	90	16	Polyimide/PTFE
M0063901030	Nitinol Zero Tip 4 Wire Basket	3.0	1.0	120	16	Polyimide/PTFE

Includes: Guidewire Introducer

# STONE RETRIEVAL DEVICES

## STAINLESS RETRIEVAL DEVICES

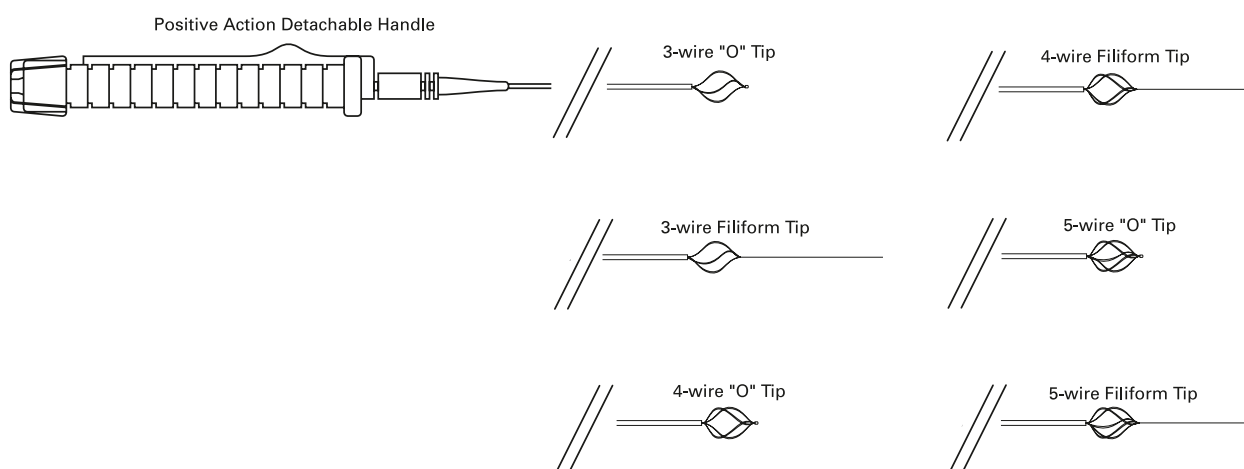

### ■ Gemini™ Paired Wire Helical Baskets

Order Number	Description	Sheath O.D. (Fr) (mm)	Working Length (cm)	Basket O.D. (mm)
M0063303040	3-Wire Basket, "O" Tip	2.4 0.8	90	11
M0063303060	3-Wire Basket, "O" Tip	2.4 0.8	120	11
M0063303070	3-Wire Basket, 5cm Filiform Tip	2.4 0.8	120	11
M0063301040	3-Wire Basket, "O" Tip	3.0 1.0	90	11
M0063301050	3-Wire Basket, 5cm Filiform Tip	3.0 1.0	90	11
M0063301060	3-Wire Basket, "O" Tip	3.0 1.0	120	11
M0063301070	3-Wire Basket, 5cm Filiform Tip	3.0 1.0	120	11
M0063301080	4-Wire Basket, "O" Tip	3.0 1.0	90	11
M0063301090	4-Wire Basket, 5cm Filiform Tip	3.0 1.0	90	11
M0063301100	4-Wire Basket, "O" Tip	3.0 1.0	120	11
M0063301110	4-Wire Basket, 5cm Filiform Tip	3.0 1.0	120	11
M0063301120	5-Wire Basket, "O" Tip	3.0 1.0	90	11
M0063301140	5-Wire Basket, 5cm Filiform Tip	3.0 1.0	90	11
M0063301150	5-Wire Basket, "O" Tip	3.0 1.0	120	11
M0063301160	5-Wire Basket, 5cm Filiform Tip	3.0 1.0	120	11
M0063302040	3-Wire Basket, "O" Tip	3.0 1.0	90	14
M0063302050	3-Wire Basket, 5cm Filiform Tip	3.0 1.0	90	14
M0063302060	3-Wire Basket, "O" Tip	3.0 1.0	120	14
M0063302080	4-Wire Basket, "O" Tip	3.0 1.0	90	14
M0063302090	4-Wire Basket, 5cm Filiform Tip	3.0 1.0	90	14
M0063302100	4-Wire Basket, "O" Tip	3.0 1.0	120	14
M0063302110	4-Wire Basket, 5cm Filiform Tip	3.0 1.0	120	14
M0063302120	5-Wire Basket, "O" Tip	3.0 1.0	90	14
M0063302140	5-Wire Basket, 5cm Filiform Tip	3.0 1.0	90	14
M0063302150	5-Wire Basket, "O" Tip	3.0 1.0	120	14

# STONE RETRIEVAL DEVICES

## STAINLESS RETRIEVAL DEVICES (Continued)

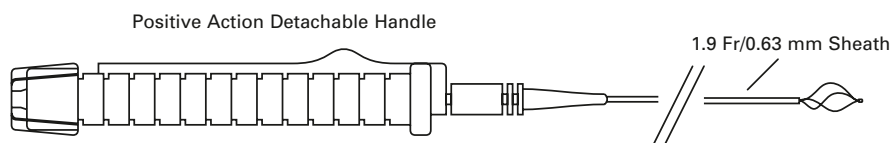

### ■ Bagley™ Helical Baskets

Order Number	Sheath O.D. (Fr) (mm)	Working Length (cm)	Basket O.D. (mm)
M006 <b>3401210</b> 0000	1.9 0.63	90	10
M006 <b>3401220</b> 0000	1.9 0.63	120	10

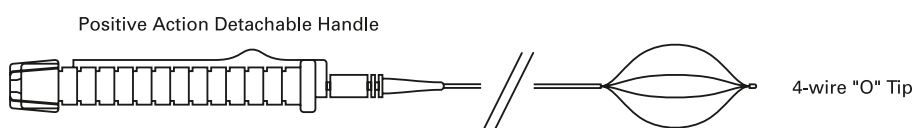

### ■ Segura Hemisphere™ Stone Retrieval Baskets

Order Number	Description	Sheath O.D. (Fr) (mm)	Working Length (cm)	Basket O.D. (mm)	Sheath Material
M006 <b>3801060</b>	4-Wire Basket, "O" Tip	2.4 0.8	90	16	Polyimide
M006 <b>3801070</b>	4-Wire Basket, "O" Tip	2.4 0.8	120	16	Polyimide
M006 <b>3801020</b>	4-Wire Basket, "O" Tip	3.0 1.0	90	16	Polyimide
M006 <b>3801000</b>	4-Wire Basket, "O" Tip	3.0 1.0	120	16	Polyimide
M006 <b>3801120</b>	4-Wire Basket, "O" Tip	3.0 1.0	90	20	Polyimide
M006 <b>3801100</b>	4-Wire Basket, "O" Tip	3.0 1.0	120	20	Polyimide
M006 <b>3801160</b>	4-Wire Basket, "O" Tip	4.5 1.5	90	16	PTFE
M006 <b>3801180</b>	4-Wire Basket, "O" Tip	4.5 1.5	90	20	PTFE
M006 <b>3801190</b>	4-Wire Basket, 5cm Filliform Tip	4.5 1.5	90	20	PTFE

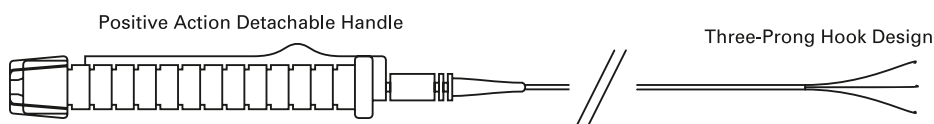

### ■ Tricep™ Hooked-Prong Grasping Forceps

Order Number	Description	Sheath Material	Sheath O.D. (Fr) (mm)	Working Length (cm)
M006 <b>3701100</b>	Retracting Grasping Forceps	PTFE	2.4 0.8	90
M006 <b>3701110</b>	Retracting Grasping Forceps	PTFE	2.4 0.8	120
M006 <b>3701000</b>	3-Prong Mini-Throw Grasping Forceps	Polyimide	3.0 1.0	90
M006 <b>3701010</b>	3-Prong Mini-Throw Grasping Forceps	Polyimide	3.0 1.0	120
M006 <b>3701140</b>	Retracting Grasping Forceps	PTFE	3.0 1.0	90
M006 <b>3701150</b>	Retracting Grasping Forceps	PTFE	3.0 1.0	120
M006 <b>3701220</b>	Extra-Strength Grasping Forceps	Polyimide	3.0 1.0	90
M006 <b>3701230</b>	Extra-Strength Grasping Forceps	Polyimide	3.0 1.0	120
M006 <b>3701180</b>	Non-Retracting Grasping Forceps	Polyimide	3.0 1.0	90
M006 <b>3701190</b>	Non-Retracting Grasping Forceps	Polyimide	3.0 1.0	120

# STONE RETRIEVAL DEVICES

## STAINLESS RETRIEVAL DEVICES (Continued)

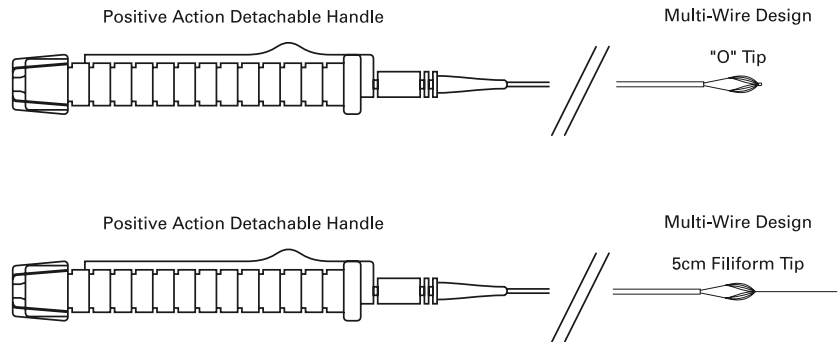

### ■ Leslie Parachute™ Multi-Wire Stone Sweeping Devices

Order Number	Description	Sheath O.D. (Fr) (mm)	Working Length (cm)	Basket O.D. (mm)
M0063203000	Leslie Parachute Basket, "O" Tip	3.1 1.0	90	11.0
M0063203010	Leslie Parachute Basket, 5cm Filiform Tip	3.1 1.0	90	11.0
M0063203020	Leslie Parachute Basket, "O" Tip	3.1 1.0	120	11.0
M0063203030	Leslie Parachute Basket, 5cm Filiform Tip	3.1 1.0	120	11.0

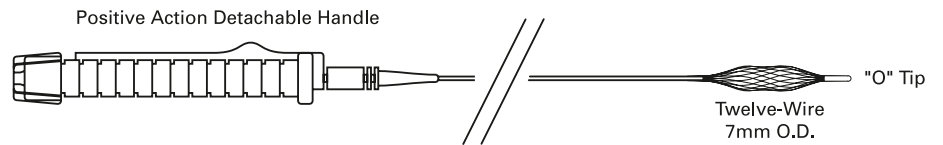

### ■ LithoCatch™ Immobilization Device

Order Number	Description	Sheath O.D. (Fr) (mm)	Working Length (cm)	Basket O.D. (mm)	Sheath Material
M0068404120	12 Wire Basket, "O" Tip	2.2 0.73	110	7.0	Polyimide



# URETERAL STENTS

## STENT STORE

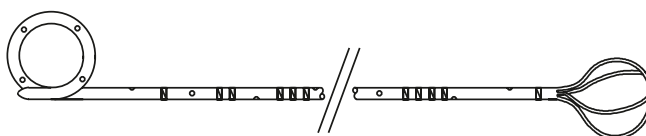

### ■ Polaris™ Loop Ureteral Stents (Dual Durometer Percuflex™ Material with HydroPlus™ Coating)

Length Between Pigtails (Fr/mm) (cm)	Without Wire	.035in/0.89mm Sensor™ PTFE-Nitinol Dual-Flex	.038in/0.97mm Sensor™ PTFE-Nitinol Dual-Flex	.038in/0.97mm Stiff Shaft PTFE Straight 3cm Flexible Tip
5.0/1.7 x 10	M0061552110	M006155211090	M006155211120	M006155211010
5.0/1.7 x 12	M0061552120	M006155212090	M006155212120	M006155212010
5.0/1.7 x 14	M0061552130	M006155213090	M006155213120	M006155213010
5.0/1.7 x 16	M0061552140	M006155214090	M006155214120	M006155214010
5.0/1.7 x 18	M0061552150	M006155215090	M006155215120	M006155215010
5.0/1.7 x 20	M0061552200	M006155220090	M006155220120	M006155220010
5.0/1.7 x 22	M0061552210	M006155221090	M006155221120	M006155221010
5.0/1.7 x 24	M0061552220	M006155222090	M006155222120	M006155222010
5.0/1.7 x 26	M0061552230	M006155223090	M006155223120	M006155223010
5.0/1.7 x 28	M0061552240	M006155224090	M006155224120	M006155224010
5.0/1.7 x 30	M0061552250	M006155225090	M006155225120	M006155225010
6.0/2.0 x 20	M0061552300	M006155230090	M006155230120	M006155230010
6.0/2.0 x 22	M0061552310	M006155231090	M006155231120	M006155231010
6.0/2.0 x 24	M0061552320	M006155232090	M006155232120	M006155232010
6.0/2.0 x 26	M0061552330	M006155233090	M006155233120	M006155233010
6.0/2.0 x 28	M0061552340	M006155234090	M006155234120	M006155234010
6.0/2.0 x 30	M0061552350	M006155235090	M006155235120	M006155235010
7.0/2.3 x 20	M0061552400	M006155240090	M006155240120	M006155240010
7.0/2.3 x 22	M0061552410	M006155241090	M006155241120	M006155241010
7.0/2.3 x 24	M0061552420	M006155242090	M006155242120	M006155242010
7.0/2.3 x 26	M0061552430	M006155243090	M006155243120	M006155243010
7.0/2.3 x 28	M0061552440	M006155244090	M006155244120	M006155244010
7.0/2.3 x 30	M0061552450	M006155245090	M006155245120	M006155245010
8.0/2.7 x 20	M0061552500	M006155250090	M006155250120	M006155250010
8.0/2.7 x 22	M0061552510	M006155251090	M006155251120	M006155251010
8.0/2.7 x 24	M0061552520	M006155252090	M006155252120	M006155252010
8.0/2.7 x 26	M0061552530	M006155253090	M006155253120	M006155253010
8.0/2.7 x 28	M0061552540	M006155254090	M006155254120	M006155254010
8.0/2.7 x 30	M0061552550	M006155255090	M006155255120	M006155255010

Each Stent Supplied with Attached Retrieval Line and Stent Positioner

Set Includes: Polaris™ Loop Dual Durometer Ureteral Stent with Percuflex™ Material and HydroPlus™ Coating, Attached Retrieval Line, Stent Positioner, Axxcess™ 6Fr/2.0mm Ureteral Catheter, Specified Guidewire



# URETERAL STENTS

## STENT STORE (Continued)

### ■ Polaris™ Loop Ureteral Stents (Dual Durometer Percuflex™ Material with HydroPlus™ Coating) (Continued)

Length Between Pigtails (Fr/mm) (cm)	.038in/0.97mm ZIPwire™		.035in/0.89mm Stiff Shaft ZIPwire		.035in/0.89mm ZIPwire		.035in/0.89mm Stiff Shaft PTFE	
	Straight 3cm Flexible Tip		Straight 3cm Flexible Tip		Straight 3cm Flexible Tip		Straight 3cm Flexible Tip	
5.0/1.7 x 10	M00615511170		M00615521180		M00615521190		M006155211050	
5.0/1.7 x 12	M00615511270		M00615521280		M00615521290		M006155212050	
5.0/1.7 x 14	M00615511370		M00615521380		M00615521390		M006155213050	
5.0/1.7 x 16	M00615511470		M00615521480		M00615521490		M006155214050	
5.0/1.7 x 18	M00615511570		M00615521580		M00615521590		M006155215050	
5.0/1.7 x 20	M00615512070		M00615522080		M00615522090		M006155220050	
5.0/1.7 x 22	M00615512170		M00615522180		M00615522190		M006155221050	
5.0/1.7 x 24	M00615512270		M00615522280		M00615522290		M006155222050	
5.0/1.7 x 26	M00615512370		M00615522380		M00615522390		M006155223050	
5.0/1.7 x 28	M00615512470		M00615522480		M00615522490		M006155224050	
5.0/1.7 x 30	M00615512570		M00615522580		M00615522590		M006155225050	
6.0/2.0 x 20	M00615513070		M00615523080		M00615523090		M006155230050	
6.0/2.0 x 22	M00615513170		M00615523180		M00615523190		M006155231050	
6.0/2.0 x 24	M00615513270		M00615523280		M00615523290		M006155232050	
6.0/2.0 x 26	M00615513370		M00615523380		M00615523390		M006155233050	
6.0/2.0 x 28	M00615513470		M00615523480		M00615523490		M006155234050	
6.0/2.0 x 30	M00615513570		M00615523580		M00615523590		M006155235050	
7.0/2.3 x 20	M00615514070		M00615524080		M00615524090		M006155240050	
7.0/2.3 x 22	M00615514170		M00615524180		M00615524190		M006155241050	
7.0/2.3 x 24	M00615514270		M00615524280		M00615524290		M006155242050	
7.0/2.3 x 26	M00615514370		M00615524380		M00615524390		M006155243050	
7.0/2.3 x 28	M00615514470		M00615524480		M00615524490		M006155244050	
7.0/2.3 x 30	M00615514570		M00615524580		M00615524590		M006155245050	
8.0/2.7 x 20	M00615515070		M00615525080		M00615525090		M006155250050	
8.0/2.7 x 22	M00615515170		M00615525180		M00615525190		M006155251050	
8.0/2.7 x 24	M00615515270		M00615525280		M00615525290		M006155252050	
8.0/2.7 x 26	M00615515370		M00615525380		M00615525390		M006155253050	
8.0/2.7 x 28	M00615515470		M00615525480		M00615525490		M006155254050	
8.0/2.7 x 30	M00615515570		M00615525580		M00615525590		M006155255050	

Each Stent Supplied with Attached Retrieval Line and Stent Positioner

Set Includes: Polaris™ Loop Dual Durometer Ureteral Stent with Percuflex™ Material and HydroPlus™ Coating, Attached Retrieval Line, Stent Positioner, Axxcess™ 6Fr/2.0mm Ureteral Catheter, Specified Guidewire

# URETERAL STENTS

## STENT STORE (Continued)

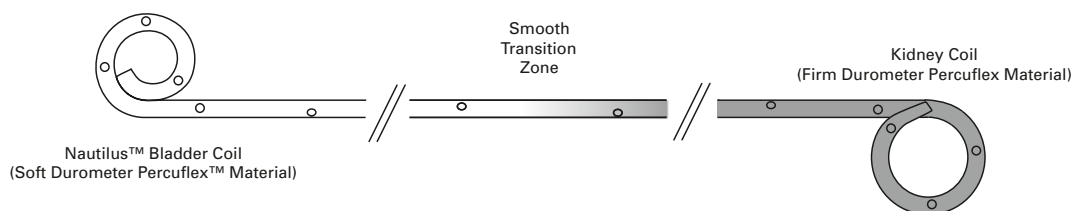

### ■ Polaris™ Ultra Ureteral Stents (Dual Durometer Percuflex™ Material with HydroPlus™ Coating)

Length Between Pigtails (Fr/mm) (cm)	Without Guidewire	.035in/0.89mm		.038in/0.97mm
		Sensor™ PTFE-Nitinol Flexible Tip		Sensor™ PTFE-Nitinol Dual-Flex
				.038in/0.97mm Stiff Shaft PTFE Straight 3cm Flexible Tip
5.0/1.7 x 10	M0061921110	M006192111090	M006192111120	M006192111010
5.0/1.7 x 12	M0061921120	M006192112090	M006192112120	M006192112010
5.0/1.7 x 14	M0061921130	M006192113090	M006192113120	M006192113010
5.0/1.7 x 16	M0061921140	M006192114090	NA	M006192114010
5.0/1.7 x 18	M0061921150	M006192115090	NA	M006192115010
5.0/1.7 x 20	M0061921200	M006192120090	NA	M006192120010
5.0/1.7 x 22	M0061921210	M006192121090	M006192121120	M006192121010
5.0/1.7 x 24	M0061921220	M006192122090	M006192122120	M006192122010
5.0/1.7 x 26	M0061921230	M006192123090	M006192123120	M006192123010
5.0/1.7 x 28	M0061921240	M006192124090	M006192124120	M006192124010
5.0/1.7 x 30	M0061921250	M006192125090	M006192125120	M006192125010
6.0/2.0 x 20	M0061921300	M006192130090	M006192130120	M006192130010
6.0/2.0 x 22	M0061921310	M006192131090	M006192131120	M006192131010
6.0/2.0 x 24	M0061921320	M006192132090	M006192132120	M006192132010
6.0/2.0 x 26	M0061921330	M006192133090	M006192133120	M006192133010
6.0/2.0 x 28	M0061921340	M006192134090	M006192134120	M006192134010
6.0/2.0 x 30	M0061921350	M006192135090	M006192135120	M006192135010
7.0/2.3 x 20	M0061921400	M006192140090	M006192140120	M006192140010
7.0/2.3 x 22	M0061921410	M006192141090	M006192141120	M006192141010
7.0/2.3 x 24	M0061921420	M006192142090	M006192142120	M006192142010
7.0/2.3 x 26	M0061921430	M006192143090	M006192143120	M006192143010
7.0/2.3 x 28	M0061921440	M006192144090	M006192144120	M006192144010
7.0/2.3 x 30	M0061921450	M006192145090	M006192145120	M006192145010
8.0/2.7 x 20	M0061921500	M006192150090	M006192150120	M006192150010
8.0/2.7 x 22	M0061921510	M006192151090	M006192151120	M006192151010
8.0/2.7 x 24	M0061921520	M006192152090	M006192152120	M006192152010
8.0/2.7 x 26	M0061921530	M006192153090	M006192153120	M006192153010
8.0/2.7 x 28	M0061921540	M006192154090	M006192154120	M006192154010
8.0/2.7 x 30	M0061921550	M006192155090	M006192155120	M006192155010

Each Stent Supplied with Attached Retrieval Line and Stent Positioner

Set Includes: Polaris™ Ultra Dual Durometer Ureteral Stent with Percuflex™ Material and HydroPlus™ Coating, and Attached Retrieval Line, Stent Positioner, Axxcess™ 6Fr/2.0mm Ureteral Catheter, Specified Guidewire

## URETERAL STENTS

### STENT STORE (Continued)

**■ Polaris™ Ultra Ureteral Stent (Dual Durometer Percuflex™ Material with HydroPlus™ Coating)**  
(Continued)

Length Between Pigtails (Fr/mm) (cm)	.038in/0.97mm ZIPwire™	.035in/0.89mm Stiff Shaft ZIPwire	.035in/0.89mm ZIPwire	.035in/0.89mm Stiff Shaft PTFE
	Straight 3cm Flexible Tip	Straight 3cm Flexible Tip	Straight 3cm Flexible Tip	Straight 3cm Flexible Tip
5.0/1.7 x 10	M006192111170	M006192111180	M006192111190	M006192111050
5.0/1.7 x 12	M006192112170	M006192112180	M006192112190	M006192112050
5.0/1.7 x 14	M006192113170	M006192113180	M006192113190	M006192113050
5.0/1.7 x 16	M006192114170	M006192114180	M006192114190	M006192114050
5.0/1.7 x 18	M006192115170	M006192115180	M006192115190	M006192115050
5.0/1.7 x 20	M006192120170	M006192120180	M006192120190	M006192120050
5.0/1.7 x 22	M006192121170	M006192121180	M006192121190	M006192121050
5.0/1.7 x 24	M006192122170	M006192122180	M006192122190	M006192122050
5.0/1.7 x 26	M006192123170	M006192123180	M006192123190	M006192123050
5.0/1.7 x 28	M006192124170	M006192124180	M006192124190	M006192124050
5.0/1.7 x 30	M006192125170	M006192125180	M006192125190	M006192125050
6.0/2.0 x 20	M006192130170	M006192130180	M006192130190	M006192130050
6.0/2.0 x 22	M006192131170	M006192131180	M006192131190	M006192131050
6.0/2.0 x 24	M006192132170	M006192132180	M006192132190	M006192132050
6.0/2.0 x 26	M006192133170	M006192133180	M006192133190	M006192133050
6.0/2.0 x 28	M006192134170	M006192134180	M006192134190	M006192134050
6.0/2.0 x 30	M006192135170	M006192135180	M006192135190	M006192135050
7.0/2.3 x 20	M006192140170	M006192140180	M006192140190	M006192140050
7.0/2.3 x 22	M006192141170	M006192141180	M006192141190	M006192141050
7.0/2.3 x 24	M006192142170	M006192142180	M006192142190	M006192142050
7.0/2.3 x 26	M006192143170	M006192143180	M006192143190	M006192143050
7.0/2.3 x 28	M006192144170	M006192144180	M006192144190	M006192144050
7.0/2.3 x 30	M006192145170	M006192145180	M006192145190	M006192145050
8.0/2.7 x 20	M006192150170	M006192150180	M006192150190	M006192150050
8.0/2.7 x 22	M006192151170	M006192151180	M006192151190	M006192151050
8.0/2.7 x 24	M006192152170	M006192152180	M006192152190	M006192152050
8.0/2.7 x 26	M006192153170	M006192153180	M006192153190	M006192153050
8.0/2.7 x 28	M006192154170	M006192154180	M006192154190	M006192154050
8.0/2.7 x 30	M006192155170	M006192155180	M006192155190	M006192155050

Set Includes: Polaris Ultra Dual Durometer Ureteral Stent with Percuflex Material and HydroPlus Coating, and Attached Retrieval Line, Stent Positioner, Axxcess™ 6Fr/2.0mm Ureteral Catheter, and Specified Guidewire

# URETERAL STENTS

## STENT STORE (Continued)

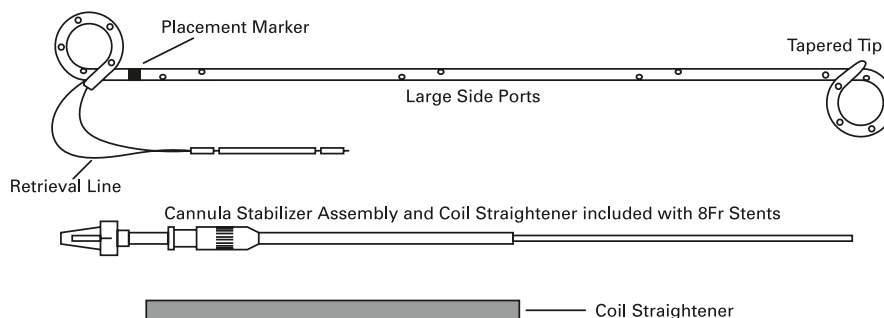

### ■ Percuflex™ Plus Ureteral Stents (with HydroPlus™ Coating)

Length Between Pigtails (Fr/mm) (cm)	Without Guidewire	.038in/0.97mm Stiff Shaft PTFE		.038in/0.97mm ZIPwire™		.035in/0.89mm Stiff Shaft ZIPwire	
		Straight 3cm Flexible Tip	Straight 3cm Flexible Tip	Straight 3cm Flexible Tip	Straight 3cm Flexible Tip		
4.8/1.6 x 10	M0061751950	NA	NA	NA	NA	M006175195180	M006175195180
4.8/1.6 x 12	M0061751960	NA	NA	NA	NA	M006175196180	M006175196180
4.8/1.6 x 14	M0061751970	NA	NA	NA	NA	M006175197180	M006175197180
4.8/1.6 x 16	M0061751980	NA	NA	NA	NA	M006175198180	M006175198180
4.8/1.6 x 18	M0061751990	NA	NA	NA	NA	M006175199180	M006175199180
4.8/1.6 x 20	M0061752500	NA	NA	NA	NA	M006175250180	M006175250180
4.8/1.6 x 22	M0061752510	NA	NA	NA	NA	M006175251180	M006175251180
4.8/1.6 x 24	M0061752520	NA	NA	NA	NA	M006175252180	M006175252180
4.8/1.6 x 26	M0061752530	NA	NA	M006175253170	M006175253170	M006175253180	M006175253180
4.8/1.6 x 28	M0061752540	NA	NA	M006175254170	M006175254170	M006175254180	M006175254180
4.8/1.6 x 30	M0061752550	NA	NA	M006175255170	M006175255170	M006175255180	M006175255180
6.0/2.0 x 20	M0061752600	M006175260010	M006175260010	M006175260170	M006175260170	M006175260180	M006175260180
6.0/2.0 x 22	M0061752610	M006175261010	M006175261010	M006175261170	M006175261170	M006175261180	M006175261180
6.0/2.0 x 24	M0061752620	M006175262010	M006175262010	M006175262170	M006175262170	M006175262180	M006175262180
6.0/2.0 x 26	M0061752630	M006175263010	M006175263010	M006175263170	M006175263170	M006175263180	M006175263180
6.0/2.0 x 28	M0061752640	M006175264010	M006175264010	M006175264170	M006175264170	M006175264180	M006175264180
6.0/2.0 x 30	M0061752650	M006175265010	M006175265010	M006175265170	M006175265170	M006175265180	M006175265180
7.0/2.3 x 20	M0061752700	M006175270010	M006175270010	M006175270170	M006175270170	M006175270180	M006175270180
7.0/2.3 x 22	M0061752710	M006175271010	M006175271010	M006175271170	M006175271170	M006175271180	M006175271180
7.0/2.3 x 24	M0061752720	M006175272010	M006175272010	M006175272170	M006175272170	M006175272180	M006175272180
7.0/2.3 x 26	M0061752730	M006175273010	M006175273010	M006175273170	M006175273170	M006175273180	M006175273180
7.0/2.3 x 28	M0061752740	M006175274010	M006175274010	M006175274170	M006175274170	M006175274180	M006175274180
7.0/2.3 x 30	M0061752750	M006175275010	M006175275010	M006175275170	M006175275170	M006175275180	M006175275180
8.0/2.7 x 20	M0061752800	M006175280010	M006175280010	M006175280170	M006175280170	M006175280180	M006175280180
8.0/2.7 x 22	M0061752810	M006175281010	M006175281010	M006175281170	M006175281170	M006175281180	M006175281180
8.0/2.7 x 24	M0061752820	M006175282010	M006175282010	M006175282170	M006175282170	M006175282180	M006175282180
8.0/2.7 x 26	M0061752830	M006175283010	M006175283010	M006175283170	M006175283170	M006175283180	M006175283180
8.0/2.7 x 28	M0061752840	M006175284010	M006175284010	M006175284170	M006175284170	M006175284180	M006175284180
8.0/2.7 x 30	M0061752850	M006175285010	M006175285010	M006175285170	M006175285170	M006175285180	M006175285180

Each Stent Supplied with Attached Retrieval Line and Stent Positioner

Set Includes: Percuflex™ Plus Stent with HydroPlus™ Coating, Axxcess™ 6Fr/2.0mm Ureteral Catheter, Specified Guidewire

8Fr/2.7mm Stents Supplied with Cannula Stabilizer Assembly and Coil Straightener

NA = Not Available

## URETERAL STENTS

### STENT STORE (Continued)

#### ■ Percuflex™ Plus Ureteral Stents (with HydroPlus™ Coating) (Continued)

Length Between Pigtails (Fr/mm) (cm)	.035in/0.89mm ZIPwire™	.035in/0.89mm Stiff Shaft PTFE	.035in/0.89mm Sensor™	.038in/0.97mm Sensor™
	Straight 3cm Flexible Tip	Straight 3cm Flexible Tip	PTFE-Nitinol Dual-Flex	PTFE-Nitinol Dual-Flex
4.8/1.6 x 10	M006175195190	M006175195050	NA	NA
4.8/1.6 x 12	M006175196190	M006175196050	NA	NA
4.8/1.6 x 14	M006175197190	M006175197050	NA	NA
4.8/1.6 x 16	M006175198190	M006175198050	M006175198090	NA
4.8/1.6 x 18	M006175199190	M006175199050	NA	NA
4.8/1.6 x 20	M006175250190	M006175250050	M006175250090	NA
4.8/1.6 x 22	M006175251190	M006175251050	M006175251090	NA
4.8/1.6 x 24	M006175252190	M006175252050	M006175252090	NA
4.8/1.6 x 26	M006175253190	M006175253050	M006175253090	NA
4.8/1.6 x 28	M006175254190	M006175254050	M006175254090	NA
4.8/1.6 x 30	M006175255190	M006175255050	M006175255090	NA
6.0/2.0 x 20	M006175260190	M006175260050	NA	M006175260120
6.0/2.0 x 22	M006175261190	M006175261050	M006175261090	M006175261120
6.0/2.0 x 24	M006175262190	M006175262050	M006175262090	M006175262120
6.0/2.0 x 26	M006175263190	M006175263050	M006175263090	M006175263120
6.0/2.0 x 28	M006175264190	M006175264050	M006175264090	M006175264120
6.0/2.0 x 30	M006175265190	M006175265050	NA	NA
7.0/2.3 x 20	M006175270190	M006175270050	M006175270090	M006175270120
7.0/2.3 x 22	M006175271190	M006175271050	M006175271090	NA
7.0/2.3 x 24	M006175272190	M006175272050	M006175272090	M006175272120
7.0/2.3 x 26	M006175273190	M006175273050	M006175273090	M006175273120
7.0/2.3 x 28	M006175274190	M006175274050	M006175274090	M006175274120
7.0/2.3 x 30	M006175275190	M006175275050	M006175275090	NA
8.0/2.7 x 20	M006175280190	NA	NA	M006175280120
8.0/2.7 x 22	M006175281190	M006175281050	NA	M006175281120
8.0/2.7 x 24	M006175282190	M006175282050	M006175282090	NA
8.0/2.7 x 26	M006175283190	M006175283050	NA	M006175283120
8.0/2.7 x 28	M006175284190	M006175284050	NA	M006175284120
8.0/2.7 x 30	M006175285190	M006175285050	NA	NA

Set Includes: Percuflex Plus™ Stent with HydroPlus™'s Coating and attached Retrieval Line, Stent Positioner, Axxcess™ 6Fr/2.0mm Ureteral Catheter and Specified Guidewire

8Fr/2.7mm Stents Supplied with Cannula Stabilizer Assembly and Coil Straightener

NA = Not Available

## URETERAL STENTS

### STENT STORE (Continued)

#### ■ Percuflex™ Plus Ureteral Stents (with HydroPlus™ Coating and Braided Retrieval Line)

Length Between Pigtails (Fr/mm) (cm)	Without Guidewire
4.8/1.6 x 22	M0061755510
4.8/1.6 x 24	M0061755520
4.8/1.6 x 26	M0061755530
4.8/1.6 x 28	M0061755540
6.0/2.0 x 20	M0061755600
6.0/2.0 x 22	M0061755610
6.0/2.0 x 24	M0061755620
6.0/2.0 x 26	M0061755630
6.0/2.0 x 28	M0061755640
6.0/2.0 x 30	M0061755650
7.0/2.3 x 22	M0061755710
7.0/2.3 x 24	M0061755720
7.0/2.3 x 26	M0061755730
7.0/2.3 x 28	M0061755740
8.0/2.7 x 22	M0061755810
8.0/2.7 x 24	M0061755820
8.0/2.7 x 26	M0061755830
8.0/2.7 x 28	M0061755840

Each Stent Supplied with Attached (Braided) Retrieval Line and Stent Positioner

Set Includes: Percuflex Plus™ Stent with HydroPlus™ Coating, Axxcess™ 6Fr/2.0mm Ureteral Catheter and Specified Guidewire

8Fr/2.7mm Stents Supplied with Cannula Stabilizer Assembly and Coil Straightener

## URETERAL STENTS

### STENT STORE (Continued)

#### ■ Contour™ Ureteral Stents (with HydroPlus™ Coating) – A Softer Percuflex™ Material Stent

Fr/mm Length Between Pigtails (Fr/mm) (cm)	Without Guidewire	.038in/0.97mm	.038in/0.97mm	.035in/0.89mm
		Stiff Shaft PTFE Straight 3cm Flexible Tip	ZIPwire™ Straight 3cm Flexible Tip	Stiff Shaft ZIPwire Straight 3cm Flexible Tip
6.0/2.0 x 20	M0061802200	M006180220010	M006180220170	M006180220190
6.0/2.0 x 22	M0061802210	M006180221010	M006180221170	M006180221190
6.0/2.0 x 24	M0061802220	M006180222010	M006180222170	M006180222190
6.0/2.0 x 26	M0061802230	M006180223010	M006180223170	M006180223190
6.0/2.0 x 28	M0061802240	M006180224010	M006180224170	M006180224190
6.0/2.0 x 30	M0061802250	M006180225010	M006180225170	M006180225190
7.0/2.3 x 20	M0061802300	M006180230010	M006180230170	M006180230190
7.0/2.3 x 22	M0061802310	M006180231010	M006180231170	M006180231190
7.0/2.3 x 24	M0061802320	M006180232010	M006180232170	M006180232190
7.0/2.3 x 26	M0061802330	M006180233010	M006180233170	M006180233190
7.0/2.3 x 28	M0061802340	M006180234010	M006180234170	M006180234190
7.0/2.3 x 30	M0061802350	M006180235010	M006180235170	M006180235190
8.0/2.7 x 20	M0061802400	M006180240010	M006180240170	M006180240190
8.0/2.7 x 22	M0061802410	M006180241010	M006180241170	M006180241190
8.0/2.7 x 24	M0061802420	M006180242010	M006180242170	M006180242190
8.0/2.7 x 26	M0061802430	M006180243010	M006180243170	M006180243190
8.0/2.7 x 28	M0061802440	M006180244010	M006180244170	M006180244190
8.0/2.7 x 30	M0061802450	M006180245010	M006180245170	M006180245190

Each Stent Supplied with Attached Retrieval Line and Stent Positioner

Set Includes: Contour™ Stent with HydroPlus Coating, Axxcess™ 6Fr/2.0mm Ureteral Catheter and Specified Guidewire

8Fr/2.7mm Stents Supplied with Cannula Stabilizer Assembly and Coil Straightener

## URETERAL STENTS

### STENT STORE (Continued)

■ **Contour™ Ureteral Stents (with HydroPlus™ Coating) – A Softer Percuflex™ Material Stent (Continued)**

Length Between Pigtails (Fr/mm) (cm)	.035in/0.89mm Stiff Shaft ZIPwire		.035in/0.89mm Stiff Shaft PTFE		.035in/0.89mm Sensor™		.038in/0.97mm Sensor	
	Straight 3cm Flexible Tip		Straight 3cm Flexible Tip		PTFE-Nitinol Dual-Flex		PTFE-Nitinol Dual-Flex	
6.0/2.0 x 20	M006180220180		M006180220050		M006180220090		M006180220120	
6.0/2.0 x 22	M006180221180		M006180221050		M006180221090		M006180221120	
6.0/2.0 x 24	M006180222180		M006180222050		M006180222090		M006180222120	
6.0/2.0 x 26	M006180223180		M006180223050		M006180223090		M006180223120	
6.0/2.0 x 28	M006180224180		M006180224050		M006180224090		M006180224120	
6.0/2.0 x 30	M006180225180		M006180225050		M006180225090		M006180225120	
7.0/2.3 x 20	M006180230180		M006180230050		M006180230090		M006180230120	
7.0/2.3 x 22	M006180231180		M006180231050		M006180231090		M006180231120	
7.0/2.3 x 24	M006180232180		M006180232050		M006180232090		M006180232120	
7.0/2.3 x 26	M006180233180		M006180233050		M006180233090		M006180233120	
7.0/2.3 x 28	M006180234180		M006180234050		M006180234090		M006180234120	
7.0/2.3 x 30	M006180235180		M006180235050		M006180235090		M006180235120	
8.0/2.7 x 20	M006180240180		NA		NA		NA	
8.0/2.7 x 22	M006180241180		M006180241050		NA		NA	
8.0/2.7 x 24	M006180242180		M006180242050		M006180242090		NA	
8.0/2.7 x 26	M006180243180		NA		NA		NA	
8.0/2.7 x 28	M006180244180		M006180244050		NA		NA	
8.0/2.7 x 30	M006180245180		NA		NA		NA	

Set Includes: Contour™ Stent with HydroPlus™ Coating and Attached Retrieval Line, Stent Positioner, Axxcess™ 6Fr/2.0mm Ureteral Catheter and Specified Guidewire

8Fr/2.7mm Stents Supplied with Cannula Stabilizer Assembly and Coil Straightener

NA = Not Available



# URETERAL STENTS

## STENT STORE (Continued)

### ■ Contour™ Ureteral Stents (with HydroPlus™ Coating and Braided Retrieval Line)

Length Between Pigtails (Fr/mm) (cm)	Without Guidewire	.038in/0.97mm	
		Stiff Shaft PTFE Straight 3cm Flexible Tip	.038in/0.97mm ZIPwire™ Straight 3cm Flexible Tip
6.0/2.0 x 20	M0061805200	NA	M006180520170
6.0/2.0 x 22	M0061805210	M006180521010	M006180521170
6.0/2.0 x 24	M0061805220	M006180522010	M006180522170
6.0/2.0 x 26	M0061805230	M006180523010	M006180523170
6.0/2.0 x 28	M0061805240	M006180524010	M006180524170
6.0/2.0 x 30	M0061805250	NA	M006180525170
7.0/2.3 x 22	M0061805310	NA	M006180531170
7.0/2.3 x 24	M0061805320	M006180532010	M006180532170
7.0/2.3 x 26	M0061805330	M006180533010	M006180533170
7.0/2.3 x 28	M0061805340	M006180534010	M006180534170
7.0/2.3 x 30	NA	NA	M006180542170
8.0/2.7 x 24	M0061805420	NA	NA
8.0/2.7 x 26	M0061805430	NA	M006180543170

Each Stent Supplied with Attached (Braided) Retrieval Line and Stent Positioner

Set includes: Contour™ Stent with HydroPlus™ Coating (with Braided Retrieval Line), Stent Positioner, Axxcess™ 6Fr/2.0mm Ureteral Catheter and Specified Guidewire

8Fr/2.7mm Stents Supplied with Cannula Stabilizer Assembly and Coil Straightener

NA = Not Available

# URETERAL STENTS

## STENT STORE (Continued)

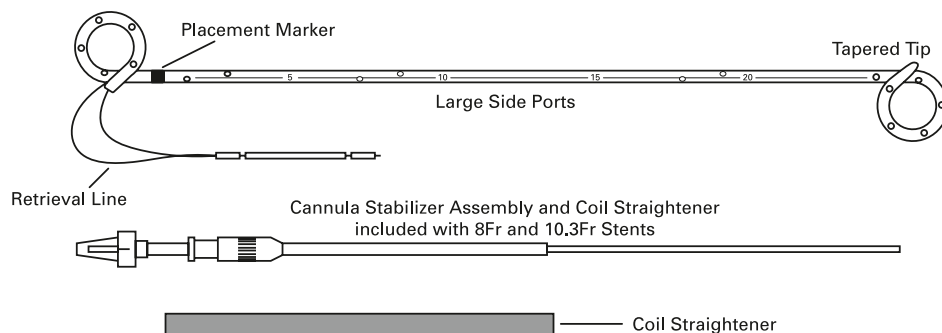

### ■ Percuflex™ Ureteral Stents

Length Between Pigtails (Fr/mm) (cm)	Without Guidewire	.038in/0.97mm Stiff Shaft PTFE Straight 3cm Flexible Tip	.038in/0.97mm ZIPwire™ Straight 3cm Flexible Tip
4.8/1.6 x 22	M0061453500	NA	M006145350170
4.8/1.6 x 24	M0061453510	NA	M006145351170
4.8/1.6 x 26	M0061453520	NA	M006145352170
4.8/1.6 x 28	M0061453530	NA	M006145353170
6.0/2.0 x 20	M0061453590	M006145359010	M006145359170
6.0/2.0 x 22	M0061453600	M006145360010	M006145360170
6.0/2.0 x 24	M0061453610	M006145361010	M006145361170
6.0/2.0 x 26	M0061453620	M006145362010	M006145362170
6.0/2.0 x 28	M0061453630	M006145363010	M006145363170
6.0/2.0 x 30	M0061453640	M006145364010	M006145364170
7.0/2.3 x 20	M0061453690	M006145369010	M006145369170
7.0/2.3 x 22	M0061453700	M006145370010	M006145370170
7.0/2.3 x 24	M0061453710	M006145371010	M006145371170
7.0/2.3 x 26	M0061453720	M006145372010	M006145372170
7.0/2.3 x 28	M0061453730	M006145373010	M006145373170
7.0/2.3 x 30	M0061453740	M006145374010	M006145374170
8.0/2.7 x 20	M0061453790	M006145379010	M006145379170
8.0/2.7 x 22	M0061453800	M006145380010	M006145380170
8.0/2.7 x 24	M0061453810	M006145381010	M006145381170
8.0/2.7 x 26	M0061453820	M006145382010	M006145382170
8.0/2.7 x 28	M0061453830	M006145383010	M006145383170
8.0/2.7 x 30	M0061453840	M006145384010	M006145384170

Each Stent Supplied with Attached Retrieval Line and Stent Positioner

Set Includes: Percuflex™ Stent, Axxcess™ 6Fr/2.0mm Ureteral Catheter and Specified Guidewire

8Fr/2.7mm Stents Supplied with Cannula Stabilizer Assembly and Coil Straightener

NA = Not Available

# URETERAL STENTS

## STENT STORE (Continued)

### ■ Percuflex™ Ureteral Stents (Continued)

Length Between Pigtails (Fr/mm) (cm)	.035 in/0.89 mm ZIPwire™		.035 in/0.89 mm Stiff Shaft PTFE	
	Straight 3cm Flexible Tip		Straight 3cm Flexible Tip	
4.8/1.6 x 20	NA		NA	
4.8/1.6 x 22	M006145350190		M006145350050	
4.8/1.6 x 24	M006145351190		M006145351050	
4.8/1.6 x 26	M006145352190		M006145352050	
4.8/1.6 x 28	M006145353190		M006145353050	
4.8/1.6 x 30	NA		NA	
6.0/2.0 x 20	M006145359190		NA	
6.0/2.0 x 22	M006145360190		NA	
6.0/2.0 x 24	M006145361190		M006145361050	
6.0/2.0 x 26	M006145362190		M006145362050	
6.0/2.0 x 28	M006145363190		M006145363050	
6.0/2.0 x 30	M006145364190		NA	
7.0/2.3 x 20	M006145369190		NA	
7.0/2.3 x 22	M006145370190		M006145370050	
7.0/2.3 x 24	M006145371190		M006145371050	
7.0/2.3 x 26	M006145372190		M006145372050	
7.0/2.3 x 28	M006145373190		M006145373050	
7.0/2.3 x 30	M006145374190		M006145374050	
8.0/2.7 x 20	M006145379190		NA	
8.0/2.7 x 22	M006145380190		NA	
8.0/2.7 x 24	M006145381190		NA	
8.0/2.7 x 26	M006145382190		NA	
8.0/2.7 x 28	M006145383190		M006145383050	
8.0/2.7 x 30	M006145384190		NA	

Set Includes: Percuflex Stent with Attached Retrieval Line, Stent Positioner, Axxcess™ 6Fr/2.0mm Ureteral Catheter and Specified Guidewire  
8Fr/2.7mm Stents Supplied with Cannula Stabilizer Assembly and Coil Straightener

NA = Not Available

## URETERAL STENTS

### STENT STORE (Continued)

#### ■ Mardis™ Soft Ureteral Stents (with HydroPlus™ Coating)

Length Between Pigtails (Fr/mm) (cm)	.035in/0.89mm Lubriglide™ Coated Guidewire	.038in/0.97mm Lubriglide™ Coated Guidewire	.038in/0.97mm ZIPwire™ Straight 3cm Flexible Tip	.035 in/0.89 mm Stiff Shaft ZIPwire™ Straight 3cm Flexible Tip
4.8/1.6 x 10	M0061251150	NA	NA	NA
4.8/1.6 x 12	M0061251160	NA	NA	NA
4.8/1.6 x 14	M0061251170	NA	NA	NA
4.8/1.6 x 16	M0061251180	NA	NA	NA
4.8/1.6 x 18	M0061251190	NA	NA	NA
4.8/1.6 x 20	NA	NA	NA	NA
4.8/1.6 x 22	M0061251210	NA	NA	NA
4.8/1.6 x 24	M0061251220	NA	NA	NA
4.8/1.6 x 26	M0061251230	NA	NA	NA
4.8/1.6 x 28	M0061251240	NA	NA	NA
4.8/1.6 x 30	NA	NA	NA	NA
6.0/2.0 x 20	NA	M0061251300	M0061265300	NA
6.0/2.0 x 22	NA	M0061251310	M0061265310	M0061265710
6.0/2.0 x 24	NA	M0061251320	M0061265320	M0061265720
6.0/2.0 x 26	NA	M0061251330	M0061265330	M0061265730
6.0/2.0 x 28	NA	M0061251340	M0061265340	M0061265740
6.0/2.0 x 30	NA	M0061251350	NA	NA
7.0/2.3 x 20	NA	M0061251400	NA	NA
7.0/2.3 x 22	NA	M0061251410	NA	NA
7.0/2.3 x 24	NA	M0061251420	M0061265420	M0061265820
7.0/2.3 x 26	NA	M0061251430	M0061265430	M0061265830
7.0/2.3 x 28	NA	M0061251440	M0061265440	M0061265840
7.0/2.3 x 30	NA	M0061251450	M0061265450	M0061265850
8.0/2.7 x 20	NA	M0061251500	NA	NA
8.0/2.7 x 22	NA	M0061251510	NA	NA
8.0/2.7 x 24	NA	M0061251520	NA	NA
8.0/2.7 x 26	NA	M0061251530	M0061265530	M0061265930
8.0/2.7 x 28	NA	M0061251540	M0061265540	M0061265940
8.0/2.7 x 30	NA	NA	NA	NA

Set Includes: Mardis™ Soft Stent with HydroPlus™ Coating with Attached Retrieval Line (except for 4.8 Fr/1.6 mm size), Stent Positioner, Specified Guidewire, Axxcess™ 6Fr/2.0mm Ureteral Catheter

NA = Not Available

# URETERAL STENTS

## STENT STORE (Continued)

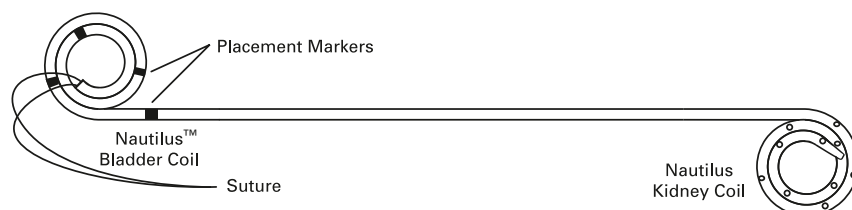

### ■ Contour VL™ Ureteral Stents (Percuflex™ Material with HydroPlus™ Coating)

Length Between Pigtails (Fr/mm) (cm)	Without Guidewire	.038in/0.97mm Stiff Shaft PTFE Straight 3cm Flexible Tip	.038in/0.97mm ZIPwire™ Straight 3cm Flexible Tip	.035in/0.89mm Stiff Shaft ZIPwire™ Straight 3cm Flexible Tip
<b>4.8/1.6 x 22-30</b>	M0061801550	M006180155010*	M006180155170*	M006180155180
<b>6.0/2.0 x 22-30</b>	M0061801560	M006180156010	M006180156170	M006180156180
<b>7.0/2.3 x 22-30</b>	M0061801570	M006180157010	M006180157170	M006180157180

Each Stent Supplied with Attached Retrieval Line and Stent Positioner

Set Includes: Contour Variable Length™ Stent, Specified Guidewire, Axxcess™ 6Fr/ 2.0mm Ureteral Catheter

\*4.8 stents only available with a .035in/0.89mm

### ■ Contour VL™ Ureteral Stents (Percuflex™ Material with HydroPlus™ Coating)

Length Between Pigtails (Fr/mm) (cm)	.035in/0.89mm ZIPwire™ Straight 3cm Flexible Tip	.035in/0.89mm Stiff Shaft PTFE Straight 3cm Flexible Tip	.035in/0.89mm Sensor™ PTFE-Nitinol 5cm Straight Tip	.035in/0.89mm Sensor™ PTFE-Nitinol Dual-Flex
<b>4.8/1.6 x 22-30</b>	M006180155190	M006180155050	NA	M006180155090
<b>6.0/2.0 x 22-30</b>	M006180156190	M006180156050	M006180156080	M006180156090
<b>7.0/2.3 x 22-30</b>	M006180157190	M006180157050	NA	NA

Set Includes: Contour Variable Length™ Stent with Attached Retrieval Line, Stent Positioner, Specified Guidewire, Axxcess™ 6Fr/2.0mm Ureteral Catheter

NA = Not Available



## URETERAL STENTS

### STENT STORE (Continued)

#### ■ Contour™ Injection Stents (with HydroPlus™ Coating) – A Percuflex™ Material Stent

Order Number	French (Fr) (mm)	Length Between Pigtailed (cm)
M0061856070*	4.8 1.6	24
M0061856080*	4.8 1.6	26
M0061856090*	4.8 1.6	28
M0061856120	6.0 2.0	22
M0061856130	6.0 2.0	24
M0061856140	6.0 2.0	26
M0061856150	6.0 2.0	28
M0061856160	6.0 2.0	30
M0061856170	7.0 2.3	20
M0061856180	7.0 2.3	22
M0061856190	7.0 2.3	24
M0061856200	7.0 2.3	26
M0061856210	7.0 2.3	28
M0061856220	7.0 2.3	30

\*4.8 Fr/1.6 mm Stents available only with a .035in/0.89 mm PTFE Coated Guidewire

Each Stent Set Supplied with Attached Retrieval, Injection Positioner and Released Sleeve with Injection Hub.

# URETERAL STENTS

## STENT STORE (Continued)

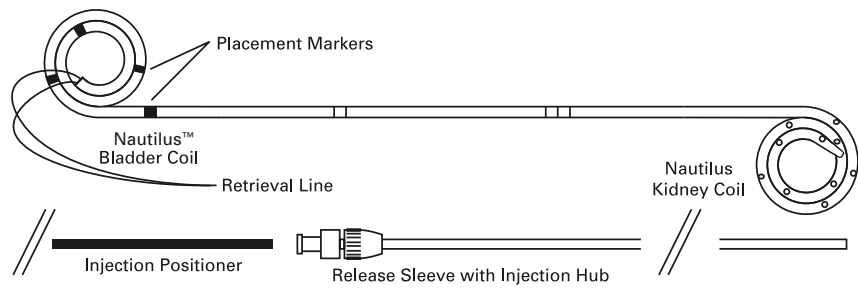

### ■ Contour VL™ Injection Stent Sets (with HydroPlus™ Coating) – A Percuflex™ Material Stent

Order Number	French (Fr)	(mm)	Length Between Pigtails (cm)
M0061856290*	4.8	1.6	30
M0061856300	6.0	2.0	30
M0061856310	7.0	2.3	30

Each Stent Supplied with Attached Retrieval Line, .038in / 0.97mm PTFE Coated Guidewire, Injection Positioner with Luer Lock Adaptor, Release Sleeve

\*4.8 Fr/1.6 mm Stents available only with a .035in / 0.89mm PTFE Coated Guidewire



# URETERAL STENTS

## STENT STORE (Continued)

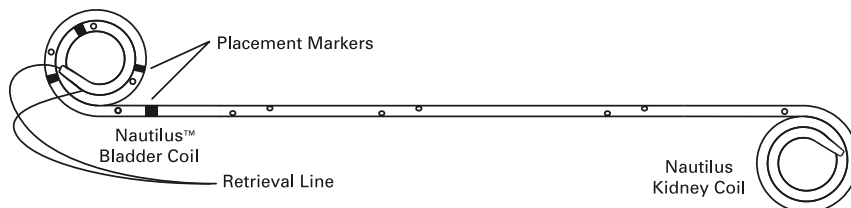

### Stretch™ VL Flexima™ Ureteral Stent Sets (with HydroPlus™ Coating)

Length Between Pigtails (Fr/mm) (cm)	Without Guidewire	.038in/0.97mm	.038in/0.97mm	.035in/0.89mm
		Stiff Shaft PTFE	ZIPwire™	Stiff Shaft ZIPwire™
		Straight 3cm	Straight 3cm	Straight 3cm
		Flexible Tip	Flexible Tip	Flexible Tip
<b>4.8/1.6 x 22-30</b>	M0061851550	NA	NA	M006185155180
<b>6.0/2.0 x 22-30</b>	M0061851560	M006185156010	M006185156170	M006185156180
<b>7.0/2.3 x 22-30</b>	M0061851570	M006185157010	M006185157170	M006185157180

Each Stent Supplied with Attached Retrieval Line and Stent Positioner

Set Includes: Stretch™ VL Stent, Specified Guidewire, Axxcess™ 6Fr/2.0mm Ureteral Catheter

### Stretch™ VL Flexima™ Ureteral Stent Sets (with HydroPlus™ Coating)

Length Between Pigtails (Fr/mm) (cm)	.035in/0.89mm	.035in/0.89mm	.035in/0.89mm
	ZIPwire™	Stiff Shaft PTFE	Sensor™
	Straight 3cm	Straight 3cm	PTFE-Nitinol
	Flexible Tip	Flexible Tip	5cm Straight Tip
<b>4.8/1.6 x 22-30</b>	M006185155190	M006185155050	M006185155080
<b>6.0/2.0 x 22-30</b>	M006185156190	NA	M006185156080
<b>7.0/2.3 x 22-30</b>	M006185157190	NA	M006185157080

Set Includes: Stretch™ VL Stent with Attached Retrieval Line, Stent Positioner, Specified Guidewire, Axxcess™ 6Fr/2.0mm Ureteral Catheter

NA = Not Available

# URETERAL STENTS

## URETERAL STENTS AND SETS

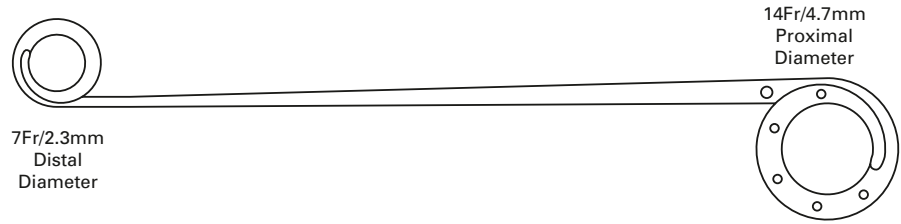

### ■ Retromax™ Plus (Endopyelotomy Stents with HydroPlus™ Coating)

Order Number	Taper Size		Length Between Pigtails (cm)
	(Fr)	(mm)	
M006 <b>1451470</b>	14/7	4.7/2.3	22
M006 <b>1451480</b>	14/7	4.7/2.3	24
M006 <b>1451490</b>	14/7	4.7/2.3	26
M006 <b>1451500</b>	14/7	4.7/2.3	28
M006 <b>1451510</b>	14/7	4.7/2.3	30

Each Stent Supplied with Metal Tip Stent Positioner

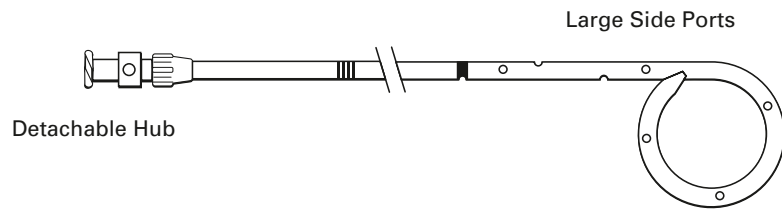

### ■ Percuflex™ Urinary Diversion Stent Sets (Open Tip Configuration)

Order Number	French		Usable Length (cm)
	(Fr)	(mm)	
M006 <b>1602050</b>	6	2.0	80
M006 <b>1602100</b>	7	2.3	80
M006 <b>1602150</b>	8	2.67	80

Set Includes: (2) Percuflex™ Urinary Diversion Stents, (1) .038in/0.97mm Stiff Bodied PTFE Coated Guidewire, (2) Color-Coded Catheter Adaptors and (2) Drainage Bag Connectors

## URETERAL STENTS

### URETERAL STENTS AND SETS (Continued)

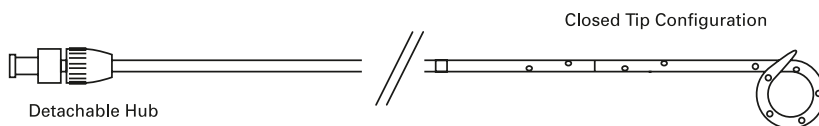

#### ■ Percufflex™ Urinary Diversion Stent Sets (Closed Tip Configuration)

Order Number	French (Fr) (mm)	Usable Length (cm)
M006 <b>1602250</b>	6 2.0	80
M006 <b>1602300</b>	7 2.3	80
M006 <b>1602350</b>	8 2.7	80

Set Includes: (2) Percufflex™ Urinary Diversion Stents, (1) .038in/0.97mm Stiff Bodied PTFE Coated Guidewire, (2) Color-Coded Catheter Adaptors and (2) Drainage Bag Connectors

## STENT ACCESSORIES

#### ■ Ureteral Stent Positioner

Order Number	French (Fr) (mm)	Length (cm)
M006 <b>1802001</b>	4.8 1.6	45
M006 <b>1802011</b>	6.0 2.0	45
M006 <b>1802021</b>	7.0 2.3	45
M006 <b>1802031</b>	8.0 2.7	45

Packaged Ten (10) Per Box

Radiopaque Marker on All Sizes Except the 4.8 Fr/1.6 mm Ureteral Stent Positioner



# URETERAL CATHETERS

## TORQUEABLE CATHETERS

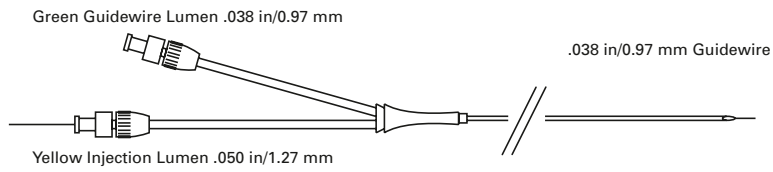

### ■ Dual Lumen™ Ureteral Catheter

Order Number	O.D. Size		Working Length (cm)	Recommended Guidewire		Injection Lumen	
	(Fr)	(mm)		(in)	(mm)	(in)	(mm)
M0064051000	10	3.3	50	.038	0.97	.050	1.7

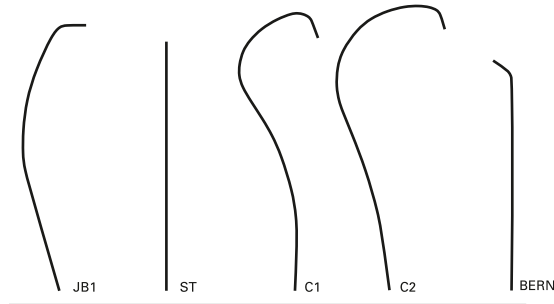

### ■ Imager™ II Catheters

Order Number	Description	O.D. Size		Working Length (cm)
		(Fr)	(mm)	
M0064003001	C1	5	1.7	65
M0064003011	C2	5	1.7	65
M0064003021	Straight	5	1.7	65
M0064003031	Bern	5	1.7	65
M0064003041	JB1	5	1.7	65
M0064004021	Straight	5	1.7	100
M0064004031	Bern	5	1.7	100
M0064004041	JB1	5	1.7	100
M0064005031	Bern	5	1.7	40

Packaged Five (5) Per Box

## URETERAL CATHETERS

### URETERAL CATHETERS

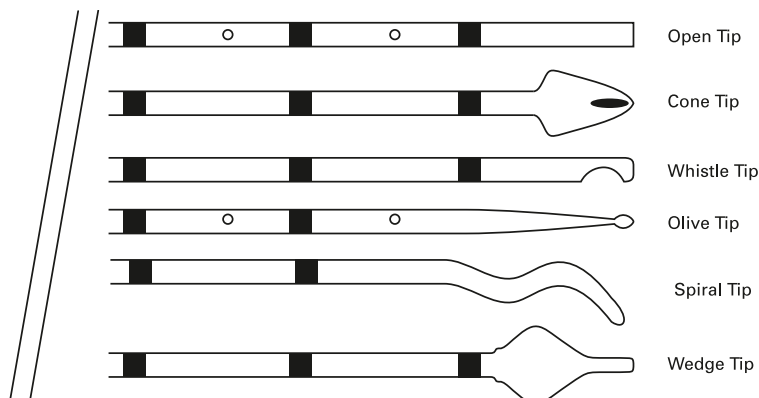

#### ■ Flexima™ Ureteral Catheters

Order Number	Description	Catheter O.D. Size		Working Length (cm)	Tip O.D. Size	
		(Fr)	(mm)		(Fr)	(mm)
M0064002001	Open End	4	1.3	70		
M0064002011	Open End	5	1.7	70		
M0064002021	Open End	6	2.0	70		
M0064002031	Open End	7	2.3	70		
M0064002041	Open End	8	2.7	70		
M0064002111	Cone Tip	5	1.7	70	8	2.7
M0064002121	Cone Tip	6	2.0	70	10	3.3
M0064002131	Cone Tip	7	2.3	70	12	4.0
M0064002141	Cone Tip	8	2.7	70	14	4.7
M0064002201	Whistle Tip	4	1.3	70		
M0064002211	Whistle Tip	5	1.7	70		
M0064002221	Whistle Tip	6	2.0	70		
M0064002301	Olive Tip	4	1.3	70		
M0064002311	Olive Tip	5	1.7	70		
M0064002361	Spiral Tip	5	1.7	70		
M0064002371	Spiral Tip	6	2.0	70		
M0064002411	Wedge Tip	5	1.7	70	14	4.7

Each Catheter Supplied with Injection Hub

Packaged Twenty (20) Per Box

#### ■ Flexima™ Ureteral Catheters (Sets with .035in/0.89mm PTFE Bentson-Tip Guidewire)

Order Number	Description	Catheter O.D. Size		Working Length (cm)	Tip O.D. Size (Fr)
		(Fr)	(mm)		
M0064002510	Angled Tip Set	5	1.3	70	-
M0064002520	Angled Tip Set	6	1.7	70	-

Set Includes: Angled Tip Catheter, .035in/0.89mm PTFE Bentson-Tip Guidewire and Injection Hub

# URETERAL CATHETERS

## URETERAL CATHETERS (Continued)

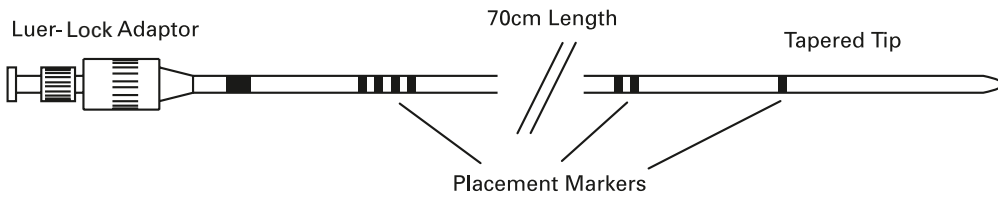

### Axxcess™ 6 French Ureteral Catheter

Order Number	Catheter O.D. Size (Fr) (mm)	Working Length (cm)
M0064001161	6 2.0	70

Packaged Ten (10) Per Box

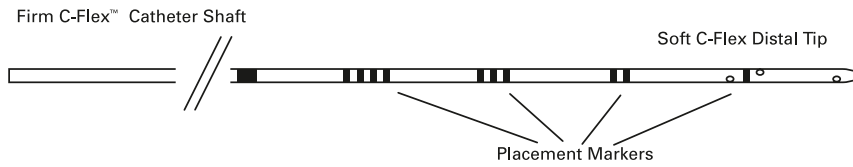

### C-Flex™ Flexible Tip Open End Ureteral Catheters (Sets)

Order Number	O.D. Size (Fr) (mm)	Working Length (cm)
M0064001400	6 2.0	70
M0064001410	7 2.3	70

Set Includes: C-Flex™ Flexible Tip Catheter, .038in/0.97mm Stainless Steel Guidewire and (2) Luer Lock Catheter Adaptors

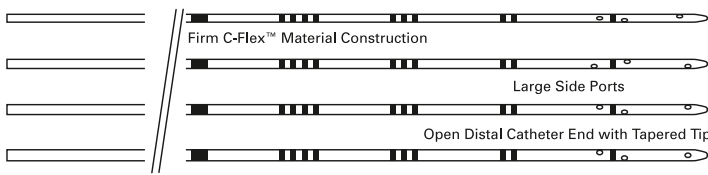

### C-Flex™ Firm Open End Ureteral Catheters (Sets)

Order Number	O.D. Size (Fr) (mm)	Working Length (cm)
M0064001500	4.8 1.2	70
M0064001510	6.0 2.0	70
M0064001520	7.0 2.3	70
M0064001530	8.0 2.7	70

Set Includes: Firm C-Flex™ Catheter, .038in/0.97mm Stainless Steel Guidewire and Two (2) Luer Lock Catheter Adaptors

## URETERAL CATHETERS

### URETERAL CATHETERS (Continued)

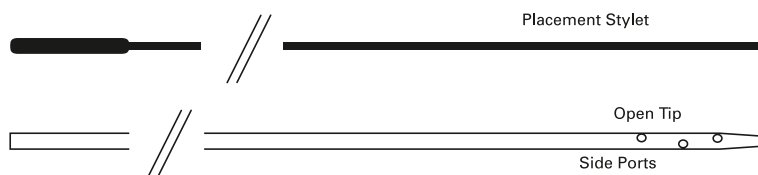

#### ■ C-Flex™ Firm Stamey Open Tip Ureteral Catheters (Sets)

Order Number	O.D. Size (Fr) (mm)	Working Length (cm)
M0064001610	4.0 1.3	70
M0064001620	4.8 1.6	70
M0064001630	6.0 2.0	70
M0064001640	7.0 2.3	70

Set Includes: Firm C-Flex™ Catheter, Placement Stylet, and Two (2) Luer Lock Catheter Adaptors

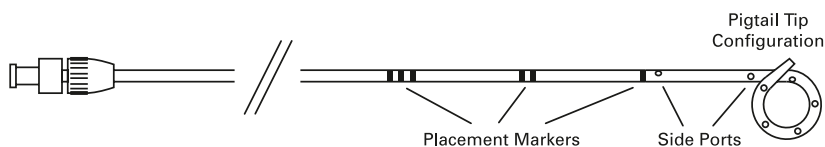

#### ■ C-Flex™ Ureteral Pigtail Catheters

Order Number	O.D. Size (Fr) (mm)	Increments of Side Ports (cm)	Working Length (cm)
M0064001700*	4.8 1.6	5	70
M0064001710	6.0 2.0	5	70
M0064001720	7.0 2.3	5	70
M0064001730	8.0 2.7	5	70

Set Includes: Firm C-Flex™ Pigtail Catheter, .038in/0.97mm Lubriglide™ Coated Guidewire and Two (2) Luer Lock Catheter Adaptors

\*Set Includes: Firm C-Flex™ Pigtail Catheter, .038in/0.97mm PTFE Coated Guidewire and Two (2) Luer Lock Catheter Adaptors





# NEPHROSTOMY PRODUCTS

## PERCUTANEOUS KITS

### ■ Lingeman Percutaneous Tract Kit with NephroMax™ High Pressure Nephrostomy Balloon Dilatation Catheter

Order Number	Description
M0064501150	Lingeman Percutaneous Tract Kit Kit Includes: 18 Gauge/O.D. 1.270mm/I.D. 0.838mm x 20cm Introducer Needle, .035in/0.89mm x 150cm Moveable Core PTFE Guidewire; .035in/0.89mm x 145cm Amplatz Super Stiff™ PTFE Coated Guidewire, .035in/0.89mm x 150cm ZIPwire™/Straight Tip Guidewire, .035in/0.89mm x 150cm Moveable Core PTFE “J” tip Guidewire; 7Fr/2.3mm Occluder™ Occlusion Balloon Catheter, 8/10Fr/2.7/3.3mm Co-axial Dilatation Set, 8Fr/2.7mm Dilator, NephroMax High Pressure Nephrostomy Balloon Dilatation Catheter Kit (Kit Includes: NephroMax High Pressure Nephrostomy Balloon Dilatation Catheter; 30Fr/10.0mm x 17cm Length PTFE Radiopaque Sheath, High Pressure Stopcock, 20ml Encore™ 26 Inflator with Pressure Gauge), 20Fr/6.7mm Re-Entry™ Malecot Nephrostomy Catheter; UroLok™ II Adaptor.

### ■ Percutaneous Tract Kit with NephroMax High Pressure Balloon Dilatation Catheter

Order Number	Description
M0064501140	Percutaneous Tract Kit with NephroMax High Pressure Balloon Dilatation Catheter Kit Includes: 8 Gauge/O.D. 1.270mm/I.D. 0.838mm x 20cm Introducer Needle, .038in/0.97mm x 150cm Stiff-bodied PTFE Guidewire, .038in/0.97mm x 145cm Amplatz Super Stiff PTFE Coated “J” Guidewire, .038in/0.97mm x 150cm ZIPwire/Straight Tip Guidewire, .038in/0.97mm x 150cm Zebra™/Angled Tip Guidewire, 7Fr/2.3mm Occluder Occlusion Balloon Catheter, 8/10 Co-axial Dilatation Set, 8Fr/2.7mm Dilator, NephroMax Nephrostomy Tract Balloon Dilatation Catheter Kit (Kit Includes: NephroMax High Pressure Nephrostomy Balloon Catheter, 30Fr/10.0mm x 17cm Length PTFE Radiopaque Sheath, High Pressure Stopcock, Encore™ 26 Inflator with Pressure Gauge), 24Fr/8.0mm Re-Entry Malecot Drainage Catheter.

### ■ Percutaneous Access Set (without Balloon or Amplatz Dilators)

Order Number	Description
M0064201100	Percutaneous Access Kit Kit Includes: 21 Gauge/O.D. 0.813mm/I.D. 0.495mm Trocar Point Needle, 19 Gauge/O.D. 3,404mm/I.D. 2,692mm Trocar Point Needle with 5Fr/1.7mm Sheath, Six Fascial Dilators (6 through 16 Fr), Catheter Retention Device, .038in/0.97mm x 150cm Length PTFE Coated Guidewire, Drainage Connecting Tube with Removable Stopcock, #11 Scalpel.

### ■ Percutaneous Access Sets – Pigtail Catheter

Order Number	O.D. Size (Fr) (mm)	Working Length (cm)
M0064201110	8 2.7	30
M0064201120*	10 3.3	30

Set Includes: C-Flex™ Pigtail Catheter, 21ga Trocar Point Needle, 19ga Trocar Point Needle with 5F PTFE Sheath, Fascial Dilators (6F–10F Even Sizes), Catheter Retention Device, .038in x 150cm x “J” Tip Stiff Bodied PTFE Coated Guidewire, Connecting Tube With Removable Stopcock, #11 Disposable Scalpel

\*Also Includes: 12Fr Fascial Dilator

Applicable Medicare C-codes:

C1729 – catheter, drainage

C1769 – guidewire

### ■ Percutaneous Access Set – Malecot Catheter

Order Number	O.D. Size (Fr) (mm)	Working Length (cm)
M0064201150	14 4.7	30

Set Includes: 14F Malecot Nephrostomy Catheter, 19ga Trocar Point Needle with 5F PTFE Sheath, Six Fascial Dilators (6F–16F Even Sizes), Catheter Retention Device, .038in x 150cm x “J” Tip Stiff Bodied PTFE Coated Guidewire, Connecting Tube With Removable Stopcock, #11 Disposable Scalpel, Removable Stylet

Applicable Medicare C-codes:

C1729 – catheter, drainage

C1769 – guidewire

# NEPHROSTOMY PRODUCTS

## JINRO™ PERCUTANEOUS KITS

### ■ Percutaneous Nephrostomy Sets – Pigtail Design

Order Number	Description	O.D. Size		Working Length (cm)
		(Fr)	(mm)	
M0064202020	Percutaneous Kit	8.3	2.8	25
M0064202040*	Percutaneous Kit	10	3.3	25

Kit Includes: Nephrostomy Kits with an extra echogenic needle and a catheter constructed of Flexima™ material for kink resistance and improved placement. Flexima™ Pigtail Catheter; Metal Stiffening Cannula with Echogenic Tip; 18 Gauge/O.D.1.270mm/I.D.0.838mm Echogenic Needle with Stylet; 21 Gauge/O.D. 0.813mm/I.D. 0.495mm Echogenic Needle with Stylet; .038in/0.97mm Guidewire with J Tip; Connecting Tube with Stopcock for Drainage Bag; 5Fr/1.7mm, 6Fr/2.0mm, 7Fr/2.3mm, 8Fr/2.7mm, 9Fr/3.0mm, 10Fr/3.3mm Fascial Dilators; Scalpel.

\* Also includes 12Fr/4.0mm Fascial Dilator.

### ■ Percutaneous Nephrostomy Sets – Replacement Kits

Order Number	Description	O.D. Size		Working Length (cm)
		(Fr)	(mm)	
M0064202060	Percutaneous Kit	8.3	2.8	25
M0064202080	Percutaneous Kit	10	3.3	25

Kit Includes: Nephrostomy Kits with an extra echogenic needle and a catheter constructed of Flexima™ material for kink resistance and improved placement. Flexima™ Pigtail Catheter with Stiffening Cannula; .038in/0.97mm 80cm J-GW; Connect Tube.

### ■ Percutaneous Nephrostomy Sets – Flexima™ Catheter Pigtail Design

Order Number	Description	O.D. Size		Working Length (cm)
		(Fr)	(mm)	
M0064202000	Percutaneous Kit	6.3	2.1	20

Kit Includes: Nephrostomy Kits with an extra echogenic needle and a catheter constructed of Flexima™ material for kink resistance and improved placement.

# NEPHROSTOMY PRODUCTS

## BALLOON DILATATION CATHETERS

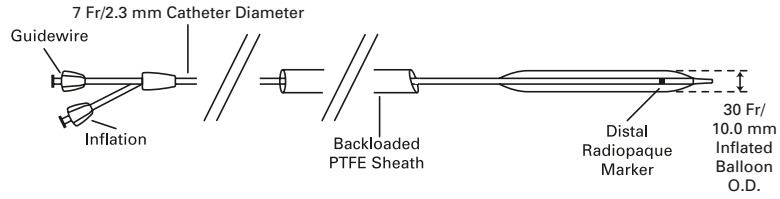

### ■ NephroMax™ High Pressure Nephrostomy Balloon Catheter

Order Number	Balloon Inflated O.D.		Balloon Length (cm)	Catheter Size		Usable Length (cm)	Sheath Type I.D. Length	
	(Fr)	(mm)		(Fr)	(mm)		(Fr)	(cm)
M0062101170	30	10	12	7	2.3	55	30	17 PTFE
M0062101400	24	8	12	7	2.3	55	24	17 PTFE
M0062101420	30	10	12	7	2.3	55	30	17 Clear
M0062101440	30	10	15	7	2.3	55	30	20 PTFE

Supplied With: High Pressure Stopcock and Sheath

### ■ NephroMax™ High Pressure Nephrostomy Balloon Catheter Kit

Order Number	Balloon Inflated O.D.		Balloon Length (cm)	Catheter Size		Usable Length (cm)	Sheath Type I.D. Length	
	(Fr)	(mm)		(Fr)	(mm)		(Fr)	(cm)
M0062101180	30	10	12	7	2.3	55	30	17 PTFE
M0062101600	24	8	12	7	2.3	55	24	17 PTFE
M0062101620	30	10	12	7	2.3	55	30	17 Clear
M0062101640	30	10	15	7	2.3	55	30	20 PTFE

Kit Includes: NephroMax™ High Pressure Nephrostomy Balloon Catheter, Renal Sheath, High Pressure Stopcock and 20ml Encore™ 26 Inflator with Pressure Gauge

## INFLATION DEVICES

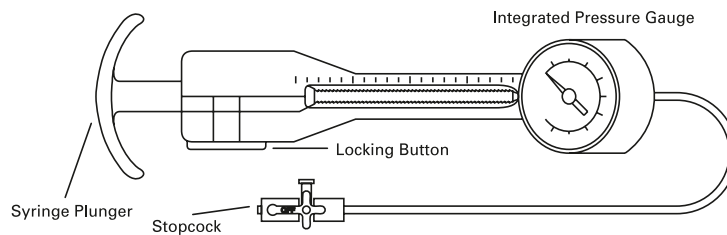

### ■ Encore™ 26 Inflator

Order Number	Description
M0067101131*	20ml Encore 26 Inflator with Pressure Gauge
M0067101140	20ml Encore 26 Inflator with Pressure Gauge

\*Packaged Five (5) Per Box

# NEPHROSTOMY PRODUCTS

## DILATORS AND SHEATHS



### ■ Clear Renal Sheath

Order Number	O.D. Size		I.D. Size		Total Length (cm)
	(Fr)	(mm)	(Fr)	(mm)	
M0062601600	34	11.3	30	10.0	17

### ■ Amplatz Type Renal Dilator/Sheath Set

Order Number	Description
--------------	-------------

M0062602500 Amplatz Type Renal Dilator/Sheath Set

Set Includes: Twelve (12) Dilators, 8Fr/2.7mm through 30Fr/10.0mm (even sizes), 35cm Length; One (1) Stylet, 8Fr/2.7mm O.D., 70cm Length; Four (4) Radiopaque PTFE Sheaths, 24Fr/8.0mm through 30Fr/10.0mm I.D., 28 Fr/9.3 mm through 34 Fr/11.3 mm O.D., 17cm Length

### ■ Amplatz Type Graduated Renal Dilator Set

Order Number	Description
--------------	-------------

M0062601000 Amplatz Type Graduated Renal Dilator Set

Set Includes: Twelve (12) Dilators, 8Fr/2.7mm through 30Fr/10.0mm (even sizes), 35cm Length; One (1) Stylet, 8Fr/2.7mm O.D., 70cm Length; One (1) Radiopaque PTFE Sheath, 8Fr/2.7mm I.D., 10Fr/3.3mm O.D., 30cm Length

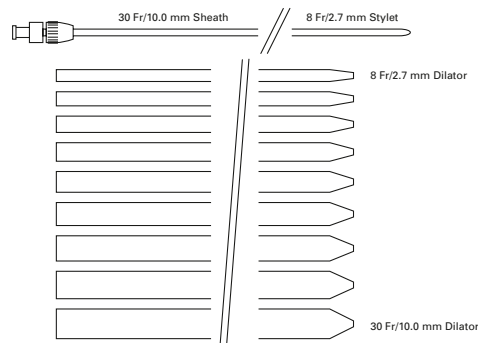

### ■ Amplatz Type Renal Dilators (Individual Components)

Order Number	O.D. Size		I.D. Size		Total Length (cm)
	(Fr)	(mm)	(Fr)	(mm)	
M0062601010	8	2.7	3	1.0	35
M0062601020	10	3.3	3	1.0	35
M0062601030	12	4.0	3	1.0	35
M0062601040	14	4.7	8	2.7	35
M0062601050	16	5.3	8	2.7	35
M0062601060	18	6.0	8	2.7	35
M0062601070	20	6.7	8	2.7	35
M0062601080	22	7.3	8	2.7	35
M0062601090	24	8.0	8	2.7	35
M0062601100	26	8.7	8	2.7	35
M0062601110	28	9.3	8	2.7	35
M0062601120	30	10.0	8	2.7	35

# NEPHROSTOMY PRODUCTS

## DILATORS AND SHEATHS (Continued)

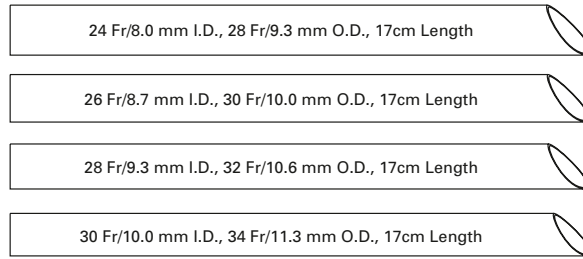

### Amplatz Type Renal Sheath (Set)

Order Number	Description
M0062601500	Amplatz Type Renal Sheath Set
Set Includes: Four (4) Radiopaque PTFE Sheaths, 24Fr/8.0mm through 30 Fr/10.0 mm I.D., 28 Fr/9.3 mm through 34 Fr/11.3 mm O.D., 17cm Length	

### Amplatz Type Renal Sheath (Individual Components)

Order Number	I.D. Size		Total Length (cm)
	(Fr)	(mm)	
M0062601450	14	4.7	17
M0062601460	16	5.3	17
M0062601470	18	6.0	17
M0062601480	20	6.7	17
M0062601490	22	7.3	17
M0062601510	24	8.0	17
M0062601520	26	8.7	17
M0062601530	28	9.3	17
M0062601540	30	10.0	17
M0069001230	30	10.0	20

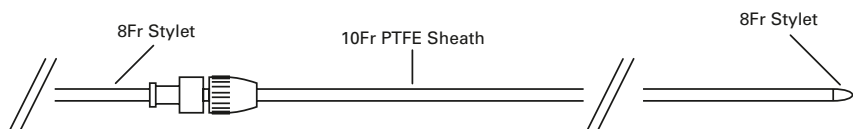

### 8/10 Dilator/Sheath Set

Order Number	Description
M0062601200	8Fr/2.7mm Stylet with 10Fr/3.3mm O.D. Safety Wire Introducer Sheath

# NEPHROSTOMY PRODUCTS

## TORQUEABLE CATHETERS

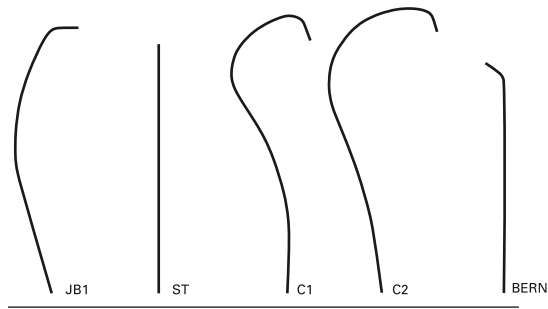

### ■ Imager™ II Catheters

Order Number	Description	O.D. Size (Fr) (mm)		Working Length (cm)
M0064003001	C1	5	1.7	65
M0064003011	C2	5	1.7	65
M0064003021	Straight	5	1.7	65
M0064003031	Bern	5	1.7	65
M0064003041	JB1	5	1.7	65
M0064004021	Straight	5	1.7	100
M0064004031	Bern	5	1.7	100
M0064004041	JB1	5	1.7	100
M0064005031	Bern	5	1.7	40

Packaged Five (5) Per Box

# NEPHROSTOMY PRODUCTS

## OCCLUSION BALLOON CATHETERS

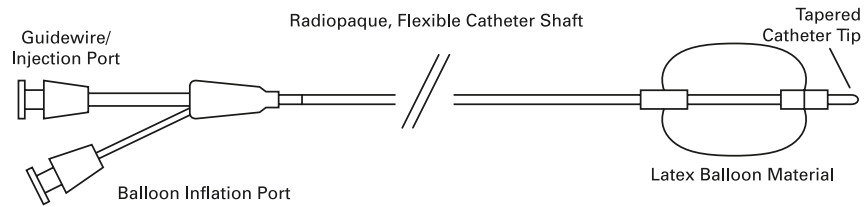

### ■ Occluder™ Occlusion Balloon Catheters contains LATEX

Order Number	Balloon Inflated O.D.		Catheter Size		Usable Length (cm)
	(Fr)	(mm)	(Fr)	(mm)	
M0062201070	26	8.7	5	1.7	65
M0062201080	26	8.7	5	1.7	100
M0062201090	34	11.3	7	2.3	65
M0062201100	34	11.3	7	2.3	100

Set Includes: Occlusion Balloon Catheter, Two-Way Stopcock and Syringe



# NEPHROSTOMY PRODUCTS

## ACCESS DEVICES

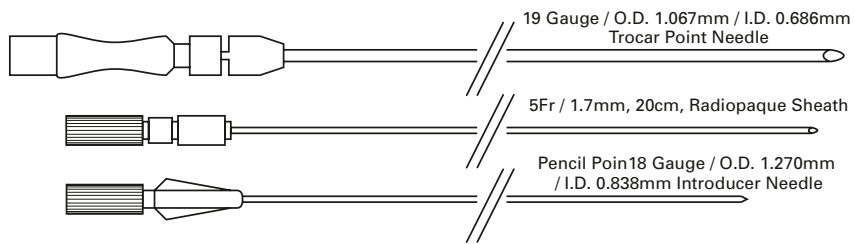

### Access Needles

Order Number	Description	Gauge	O.D. (mm)	I.D. (mm)
M0067001200	TLA Introducer Needle and Sheath Set	19	1.067	0.686
M0067001210	12cm Introducer Needle Set	18	1.270	0.838
M0067001220	20cm Introducer Needle Set	18	1.270	0.838
M0067001230	20cm Introducer Needle Set with Echoblast	18	1.270	0.838

# NEPHROSTOMY PRODUCTS

## DRAINAGE CATHETERS

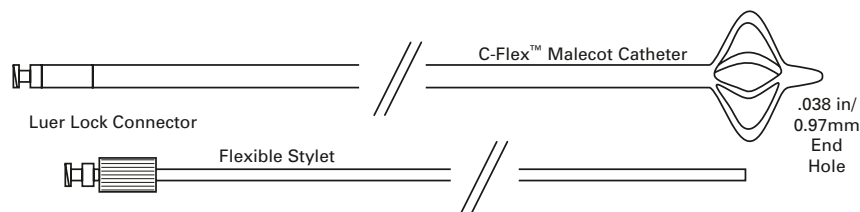

### ■ Malecot Nephrostomy Catheters

Order Number	O.D. Size		Working Length (cm)
	(Fr)	(mm)	
M0064101000	14	4.7	35
M0064101010	16	5.3	35
M0064101020	20	6.7	35
M0064101030	24	8.0	35

Set Includes: C-Flex™ Malecot Catheter, Two Flexible Stylets and Drainage Bag Connecting Tube

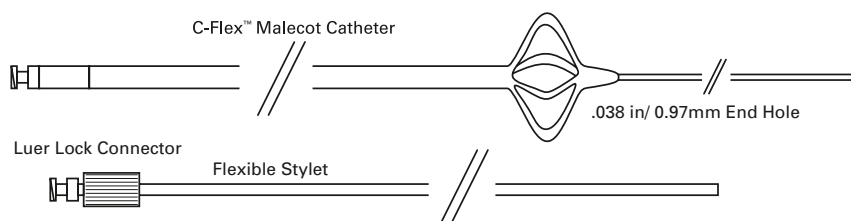

### ■ Re-Entry™ Malecot Nephrostomy Catheters

Order Number	Catheter O.D. Size		Catheter Working Length (cm)	Re-Entry Tip O.D. Size (Fr)	Re-Entry Tip Length (cm)
	(Fr)	(mm)			
M0064101040	14	4.7	35	6	15
M0064101050	16	5.3	35	6	15
M0064101060	20	6.7	35	8	18
M0064101070	24	8.0	35	8	18

Set Includes: C-Flex™ Re-Entry Malecot Catheter, Two Flexible Stylets and Drainage Bag Connecting Tube

# NEPHROSTOMY PRODUCTS

## DRAINAGE CATHETERS (Continued)

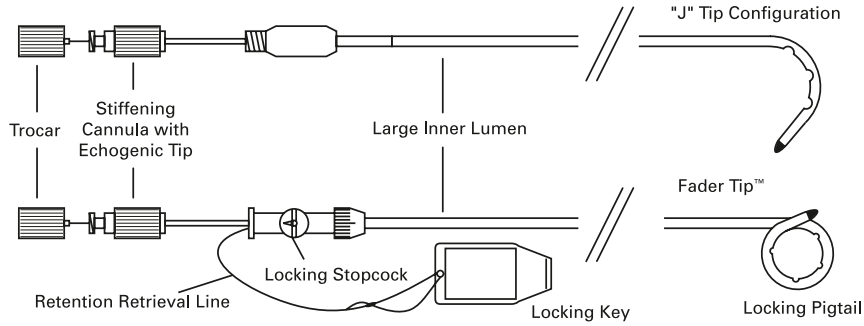

### ■ Percuflex™ Locking Loop All Purpose Drainage Catheter with Fader Tip™

Order Number	O.D. Size		Working Length (cm)
	(Fr)	(mm)	
M0064102020	8	2.7	19
M0064102030	10	3.3	19

Set Includes: Percuflex™ APD Catheter with Fader Tip™ and Locking Pigtail, Trocar Stylet and Stiffening Cannula

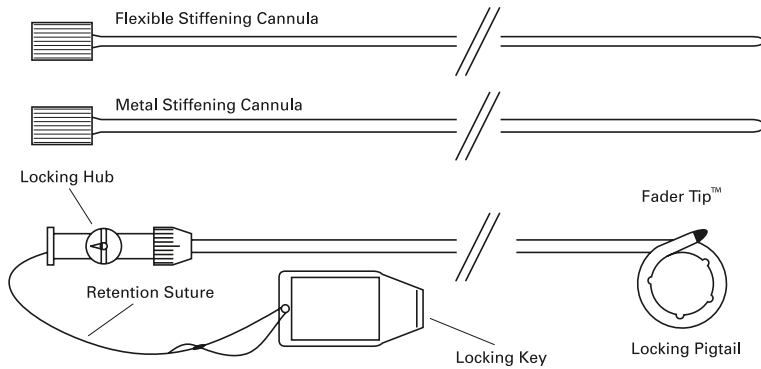

### ■ Percuflex™ Locking Loop Nephrostomy Catheters with Fader Tip™

Order Number	O.D. Size		Working Length (cm)
	(Fr)	(mm)	
M0064102040	8	2.7	26
M0064102050	10	3.3	27.6
M0064102060	12	4.0	26

Supplied With: Metal Stiffening Cannula, Flexible Stiffening Cannula and Septum Cap

# NEPHROSTOMY PRODUCTS

## DRAINAGE CATHETERS (Continued)

### ■ Percuflex™ Locking Loop Nephrostomy Catheters with Fader Tip™ (Kits)

Order Number	O.D. Size		Working Length (cm)
	(Fr)	(mm)	
M0064103040	8	2.7	26
M0064103050	10	3.3	27.6

Kit Includes: Percuflex™ Nephrostomy Catheter; Metal Stiffening Cannula; Flexible Stiffening Cannula; Accustick™ Introducer; 6Fr/2.0mm Sheath, 4 Fr/1.3 mm Dilator with Locking Cannula; 21 Gauge/O.D. 3.048mm/I.D. 2.388 Diagnostic Needle with Stylet; .018in/0.46mm Extra Stiff Guidewire with Floppy Platinum Tip; .038in/0.97mm Heavy Duty Guidewire with 2mm „J“ and Floppy Tip; Percuflex™ Catheter Cuff; Sheet of Moisture Vapor Permeable Dressing, Connecting Tube with Stopcock; Fascial Dilators: 8Fr/2.7mm in 8Fr/2.7mm Kit; 8Fr/2.7mm and 10Fr/3.3mm in 10Fr/3.3mm Kit; 8Fr/2.7mm, 10Fr/3.3mm and 12Fr/4.0mm in 12Fr/4.0mm Kit; 8Fr/2.7mm, 10Fr/3.3mm, 12Fr/4.0mm and 14Fr/4.7mm in 14Fr/4.7mm Kit

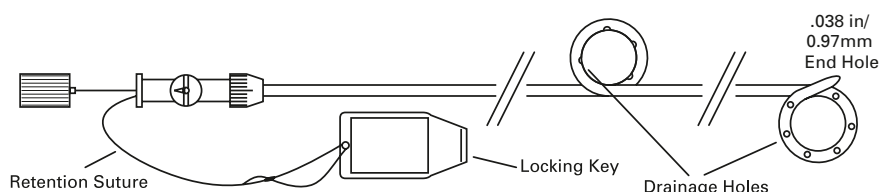

### ■ Percuflex™ Combination Stent/Nephrostomy Catheter

Order Number	O.D. Size		Working Length From Hub to Loop (cm)	Length From Loop to Tip (cm)
	(Fr)	(mm)		
M0064101260	8	2.7	25	24

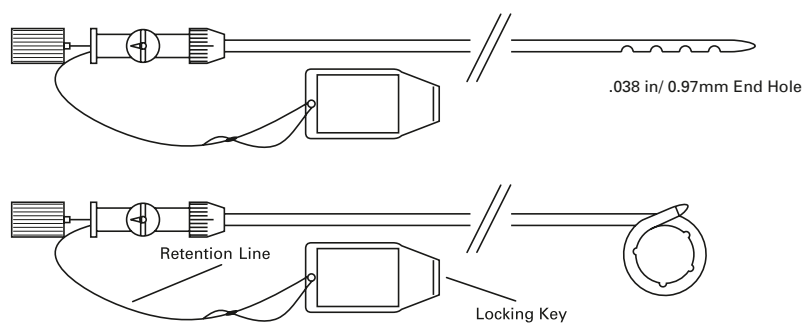

### ■ Percuflex™ Locking Loop Nephrostomy Catheters

Order Number	Working O.D. Size		Length (cm)
	(Fr)	(mm)	
M0064101110	8	2.7	26.5
M0064101120	10	3.3	28.3

# NEPHROSTOMY PRODUCTS

## DRAINAGE CATHETERS (Continued)

### ■ Percutaneous Nephrostomy Sets – Pigtail Design

Order Number	O.D. Size		Working Length (cm)
	(Fr)	(mm)	
M0064201110	8	2.7	30
M0064201120*	10	3.3	30

Set Includes: C-Flex™ Pigtail Catheter; 21 Gauge Trocar Point Needle; 19 Gauge / O.D. 3,404mm / I.D. 2,692mm Trocar Point Needle; 5Fr / 1.7mm PTFE Sheath; 6Fr / 2.0mm, 8Fr / 2.7mm and 10Fr / 3.3mm Fascial Dilators; Percufix™ Catheter Cuff; .038in / 0.97mm 150cm Length PTFE Coated Guidewire; Drainage Connecting Tube with Removable Stopcock; #11 Scalpel

\*Also Includes: 12Fr / 4.0mm Fascial Dilator

### ■ Percutaneous Nephrostomy Catheter Set – Malecot Design

Order Number	O.D. Size		Working Length (cm)
	(Fr)	(mm)	
M0064201150	14	4.7	30

Set Includes: C-Flex™ Malecot Nephrostomy Catheter; 21 Gauge Trocar Point Needle; 19 Gauge / O.D. 3,404mm / I.D. 2,692mm Trocar Point Needle with 5Fr / 1.7mm PTFE Sheath; 6Fr / 2.0mm, 8Fr / 2.7mm, 10Fr / 3.3mm, 12Fr / 4.0mm, 14Fr and 16Fr Fascial Dilators; Percufix™ Catheter Cuff; .038in / 0.97mm 150cm Length PTFE Coated Guidewire; Drainage Connecting Tube with Removable Stopcock; #11 Scalpel





## BIOPSY DEVICES

### FORCEPS

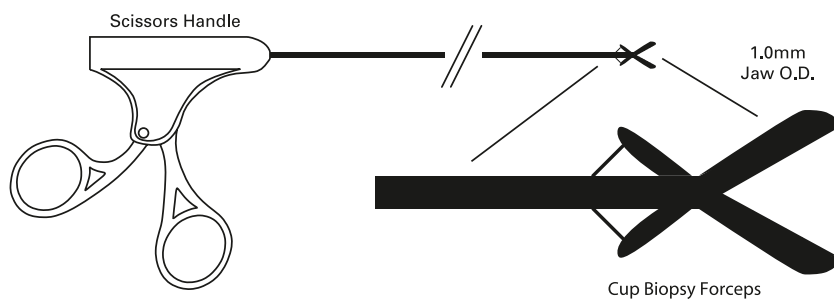

#### ■ Piranha™ 3Fr/1.0mm Ureteroscopic Biopsy Forceps

Order Number	Jaw O.D. (mm)	Length (cm)	Recommended Working Channel (mm)
M0065051600	1.0	115	1.1

## SUTURING DEVICES

### SUTURE CAPTURING DEVICES

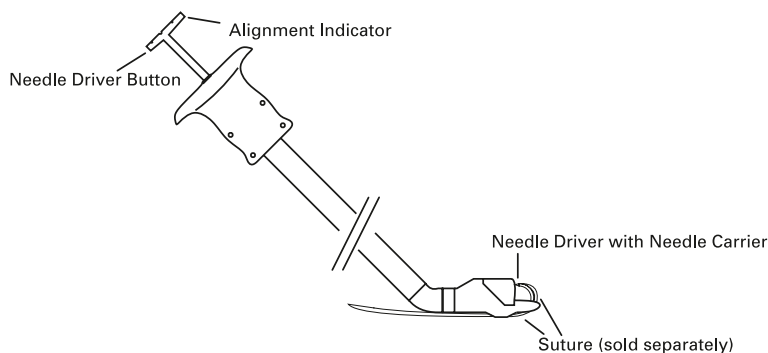

#### ■ Capiro™ RP Suturing Device for Radical Prostatectomy

Order Number	Description	Size
M0068321010	Capiro™ RP Suture capturing device for an open radical prostatectomy	
M0068331351	Absorbable, monofilament POLYGLYTONE™ Suture, with TC taperpoint needle and a T 26mm 1/2 circle taper needle, 36in/91.5cm (Packaged twelve (12) per box)	2.0
M0068331361	Bondek™ Absorbable, braided coated PGA suture, with TC taperpoint needle and a T 26mm 1/2 circle taper needle, 36in/91.5cm (Packaged twelve (12) per box)	2.0





# ELECTROSURGICAL PRODUCTS

## RESECTION DEVICES FOR USE WITH VARIOUS RESECTOSCOPES

### ■ Compatible for Use with Storz Brand Single Stem Resectoscope

Order Number	Resection Device	Sheath O.D.	
		(Fr)	(mm)
M0068802031	Cutting Loop (10/bx)	24	8.0
M0068802041	Cutting Loop (10/bx)	27	9.0
M0068802051	3mm Rollerball Electrode (10/bx)	24	8.0
M0068802061	3mm Rollerball Electrode (10/bx)	27	9.0
M0068802011	Powerball Electrode (5/bx)	24	8.0
M0068802071	TUIP Knife (10/bx)	24	8.0

### ■ Compatible for Use with Storz Brand Double Stem Resectoscope

Order Number	Resection Device	Sheath O.D.	
		(Fr)	(mm)
M0068802231	Cutting Loop (10/bx)	24	8.0
M0068802241	Cutting Loop (10/bx)	27	9.0
M0068802251	3mm Rollerball Electrode (10/bx)	24	8.0
M0068802211	Powerball™ Electrode (5/bx)	24	8.0
M0068802271	TUIP Knife (10/bx)	24	8.0

### ■ Compatible for Use with Olympus Brand OES™ Resectoscope

Order Number	Resection Device	Sheath O.D.	
		(Fr)	(mm)
M0068802331	Cutting Loop (10/bx)	24	8.0
M0068802341	Cutting Loop (10/bx)	26	8.7
M0068802351	3mm Rollerball Electrode (10/bx)	24	8.0
M0068802361	3mm Rollerball Electrode (10/bx)	26	8.7
M0068802311	Powerball Electrode (5/bx)	24	8.0
M0068802371	TUIP Knife (10/bx)	24	8.0

### ■ Compatible for Use with Olympus Brand OES-Pro™ Series Resectoscope

Order Number	Resection Device	Sheath O.D.	
		(Fr)	(mm)
M0068802611	Cutting Loop (10/bx)	24	8.0
M0068802621	Cutting Loop (10/bx)	26	8.7
M0068802641	3mm Rollerball (10/bx)	24	8.0
M0068802651	5mm Rollerball (10/bx)	24	8.0
M0068802671	TUIP Knife (10/bx)	24	8.0
M0068802681	Incision Blade (10/bx)	24	8.0

### ■ Compatible for Use with Wolf Brand E-line Series Resectoscope

Order Number	Resection Device	Sheath O.D.	
		(Fr)	(mm)
M0068802431	Cutting Loop (10/bx)	24	8.0
M0068802451	3mm Rollerball Electrode (10/bx)	24	8.0
M0068802411	Powerball Electrode (5/bx)	24	8.0
M0068802471	TUIP Knife (10/bx)	24	8.0



## PROCEDURE ACCESSORIES

### INFLATION DEVICES

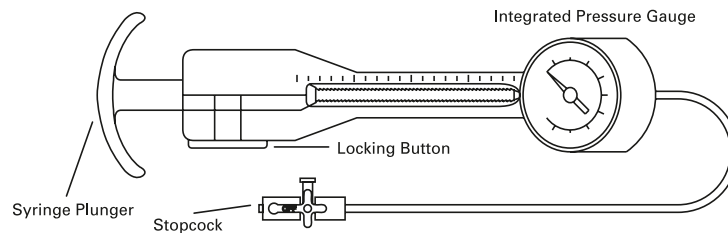

#### ■ Encore™ 26 Inflator

Order Number	Description
M0067101131*	20ml Encore 26 Inflator with Pressure Gauge
M0067101140	20ml Encore 26 Inflator with Pressure Gauge

\*Packaged Five (5) Per Box

### IRRIGATION, EVACUATION AND RESECTION ACCESSORIES

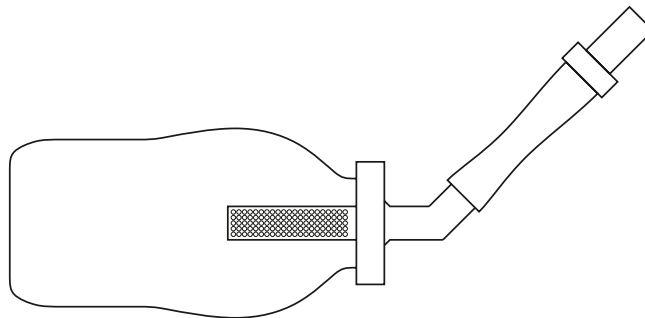

#### ■ Urovac™ Bladder Evacuator

contains  
LATEX

Order Number	Description
M0067301251	Urovac Bladder Evacuator with Adaptor

Packaged Ten (10) Per Box

## PROCEDURE ACCESSORIES

### IRRIGATION, EVACUATION AND RESECTION ACCESSORIES (Continued)

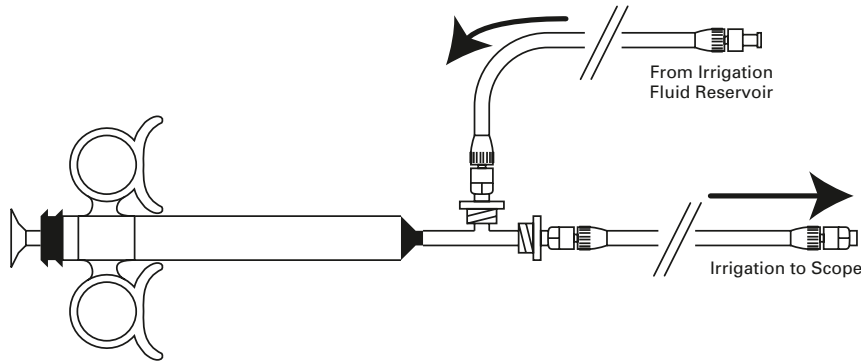

#### ■ SAPS™ Single Action Pumping System

Order Number	Description
M0067201001	Single Action Pumping System
System Includes: 10ml Vacuum Syringe, Check Valve with Adjustable Length Connecting Tubes	
Packaged Five (5) Per Box	

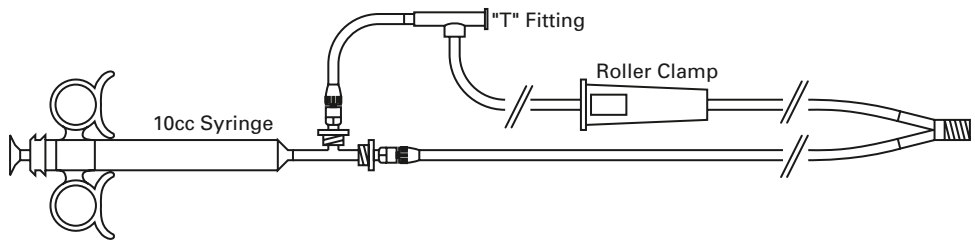

#### ■ SAPS™ CF Continuous Flow Single Action Pumping System

Order Number	Description
M0067201011	Single Action Pumping System CF
System Includes: 10ml Vacuum Syringe, Continuous Flow Adjustable Length Tubing System with Dual-Check Valve and Roller Clamp	

# PROCEDURE ACCESSORIES

## OTHER

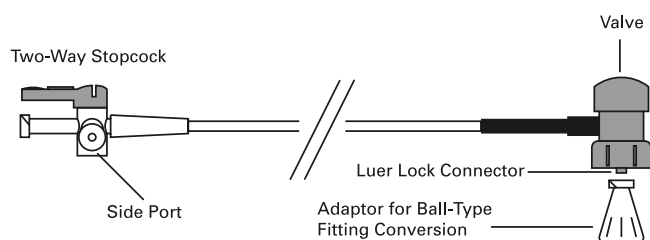

### ■ UroLok™ II Scope Adaptor

Order Number	Description
M0067301401	UroLok II with Ball-fitting Adaptor

Packaged Ten (10) Per Box

### ■ Gateway™ Advantage Y Adaptor

Order Number	Description
M0067301501	Gateway Advantage Y-Adaptor

Packaged Ten (10) Per Box

### ■ Connecting Tubes for Drainage Bag

Order Number	Description
M0067401000	30cm Connecting Tube for 3 Fr/1 mm through 6Fr / 2.0mm Catheters
M0067401010	30cm Connecting Tube for 7 Fr/2.3 mm through 10Fr / 3.3mm Catheters
M0067401020	30cm "Y" Connecting Tube for Two 3 Fr/1 mm through 6Fr / 2.0mm Catheters

### ■ Ureteral Catheter Connectors

Order Number	Description
M0067401100	Connection for 3 Fr/1 mm through 6Fr / 2.0mm Catheters with Luer Lock Fitting
M0067401110	Connection for 7 Fr/2.3 mm through 10Fr / 3.3mm Catheters with Luer Lock Fitting

### ■ Drainage Bag Connectors

Order Number	Descriptions
M0067401200	Connection for Female Luer Lock Fitting to Drainage Bag
M0067401220	Connection for 3 Fr/1 mm through 6Fr / 2.0mm Ureteral Catheters to Drainage Bag



# PELVIC FLOOR PRODUCTS

## MID-URETHRAL SLING SYSTEMS

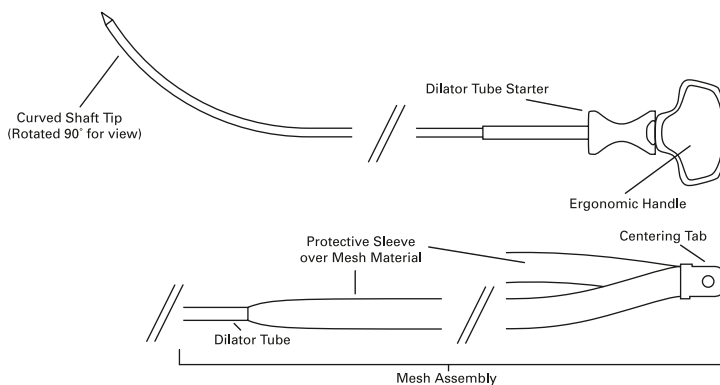

### ■ Advantage™ System (Transvaginal)

Order Number	Description
M0068502000	Advantage System (single unit)
M006850200051	Advantage System (5/bx)

Each System Includes One (1) Delivery Device and One (1) Mesh Assembly

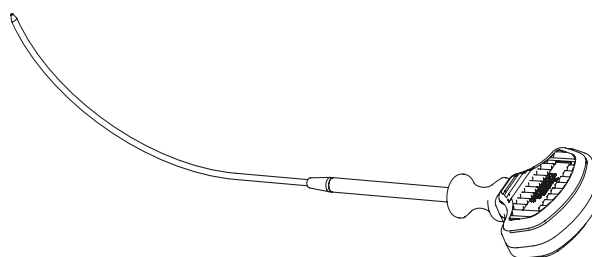

### ■ Advantage Fit™ System (Transvaginal)

Order Number	Description
M0068502110	Advantage Fit System (single unit)
M0068502111	Advantage Fit System (5/bx)

Each System Includes One (1) Delivery Device and One (1) Mesh Assembly

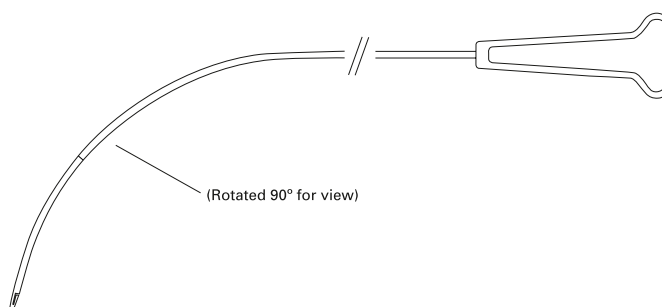

### ■ Lynx™ System (Suprapubic)

Order Number	Description
M0068503000	Lynx System (single unit)
M0068503001	Lynx System (5/bx)

Each System Includes One (1) Delivery Device and One (1) Mesh Assembly



# PELVIC FLOOR PRODUCTS

## MID-URETHRAL SLING SYSTEMS (Continued)

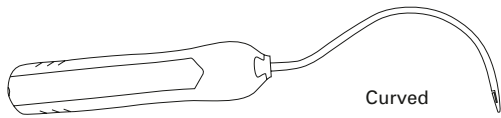

Curved

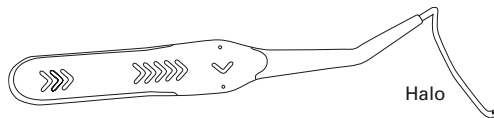

Halo

### **NEW** ■ Obtryx™ II Transobturator Mid-Urethral Sling System

Order Number	Description
M0068504110*	Obtryx™ II Transobturator Sling System - Curved
M0068504111**	Obtryx™ II Transobturator Sling System - Curved
M0068505110*	Obtryx™ II Transobturator Sling System - Halo
M0068505111**	Obtryx™ II Transobturator Sling System - Halo

\*Packaged One (1) Per Box

\*\*Packaged Five (5) Per Box

### ■ Obtryx™ System Halo or Curved (Transobturator)

Order Number	Description
M0068504000	Obtryx System Curved (single unit)
M0068504001	Obtryx System Curved (5/bx)
M0068505000	Obtryx System Halo (single unit)
M0068505001	Obtryx System Halo (5/bx)

Each System includes One (1) Delivery Device and One (1) Mesh Assembly

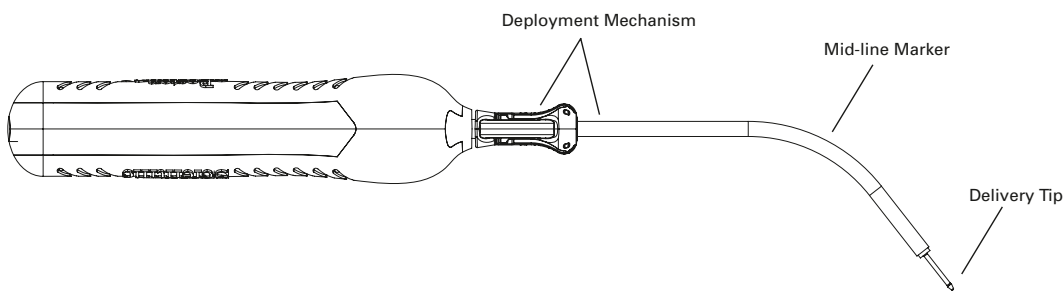

### ■ Solyx™ SIS System

Order Number	Description
M0068507000	Solyx SIS System (single unit)
M0068507001	Solyx SIS System (5/bx)

Each System includes One (1) Delivery Device and One (1) Mesh Assembly

# PELVIC FLOOR PRODUCTS

## CAPIO SLIM SUTURE CAPTURING DEVICE

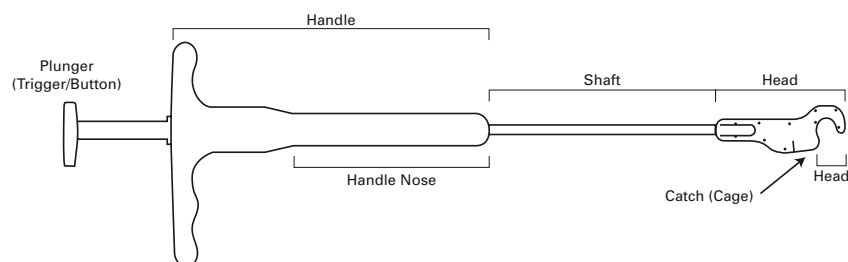

### **NEW** ■ Capio™ SLIM Suture Capturing Device

Order Number	Description
M0068318250*	Capio Slim Suture Capturing Device
M0068318261**	Capio Slim Suture Capturing Device

\*Packaged One (1) Per Box

\*\*Packaged Five (5) Per Box

### ■ Capio™ Suture Capturing Devices

Order Number	Description	Size
M0068312321	Standard – for direct vision endoscopic, open or transvaginal use	12mm x 32cm

Packaged Four (4) Per Box

### ■ Capio™ Sutures

Order Number	Description	Size	Comparable Products
M0068331131	Non-absorbable, coated braided polyester, double armed with TC tapercut needles, 48 in/122 cm	0	TI-CRON™ Sutures / Ethibond™ Sutures
M0068331231	Non-absorbable, polypropylene monofilament, double armed with TC tapercut needles, 48 in/122 cm	0	Surgilene™ Sutures / Prolene™ Sutures
M0068332131	Absorbable, coated braided PGA, double armed with TC tapercut needles, 48 in/122 cm	0	Dexon™ II Sutures / Vicryl™ Sutures
M0068331141	Non-absorbable, coated braided polyester, double armed with TC tapercut needle and a T 26mm 1/2 circle taper needle, 36 in/91,5 cm	0	TI-CRON™ Sutures / Ethibond™ Sutures
M0068331241	Non-absorbable, polypropylene monofilament, double armed with TC tapercut needle and a T 26mm 1/2 circle taper needle, 36 in/91,5 cm	0	Surgilene™ Sutures / Prolene™ Sutures
M0068331371	Monodek™ Absorbable, monofilament PDO, double armed with TC tapercut needle and a T 26mm 1/2 circle taper needle, 48 in/122 cm	0	PDS™ Sutures

Packaged Twelve (12) Per Box

## PELVIC FLOOR PRODUCTS

### RECONSTRUCTION GRAFTS

#### ■ Xenform™ Soft Tissue Repair Matrix

Order Number	Description	Size (cm)
M0068302410	Xenform Tissue Repair Matrix	2 x 7
M0068302430	Xenform Tissue Repair Matrix	4 x 7
M0068302450	Xenform Tissue Repair Matrix	6 x 10
M0068302470	Xenform Tissue Repair Matrix	8 x 12

#### ■ Polyform™ Synthetic Mesh

Order Number	Description	Size (cm)
M0068402400	Polyform Synthetic Mesh	10 x 15
M0068402401	Polyform Synthetic Mesh (5/bx)	10 x 15
M0068402410	Polyform Synthetic Mesh	15 x 20

### RECONSTRUCTION KITS

#### ■ Pinnacle™ Pelvic Floor Repair Kits

Order Number	Description
M0068318150	Pinnacle Lite Posterior

Kit Includes: One (1) Mesh Assembly PELVIC FLOOR PRODUCTS

#### ■ Uphold™ Lite Vaginal Support System

Order Number	Description
M0068318170	Uphold Lite Vaginal Support System

Kit Includes: One (1) Capio™ SLIM Device and (1) Uphold Mesh Assembly

(1) Uphold Mesh Assembly

#### **NEW** ■ Upsilon™ Y-Mesh and Colpassist Vaginal Positioning Device

Order Number	Description
M0068318220	Upsilon Y-Mesh and Colpassist Vaginal Positioning Device Kit

Kit Includes: One (1) Upsilon™ Y-Mesh and One (1) Colpassist Vaginal Positioning Device

## PELVIC FLOOR PRODUCTS

### ENDOMETRIAL ABLATION SYSTEM

#### ■ Genesys HTA™ System

---

Order Number	Description
M006580020*	Genesys HTA 230V Control Unit – English 1 each
M006582110*	Genesys HTA 230V Control Unit– Danish 1 each
M006582210*	Genesys HTA 230V Control Unit – Swedish 1 each
M006582310*	Genesys HTA 230V Control Unit – French 1 each
M006582410*	Genesys HTA 230V Control Unit – Italian 1 each
M006580040**	Genesys HTA Pedestal 1 each

\*Includes: Control unit, User's Manual and power cord

\*\*Includes: Pedestal pole, pedestal base and IV pole. Must be ordered with control unit.

#### ■ Genesys HTA ProCerva™ Procedure Set

---

Order Number	Description
M006580201	Genesys HTA ProCerva Procedure Set Box of 5

\*Includes: Cassette, Drain Bag and Procedure Sheath

#### ■ HTA™ System Hysteroscope Adaptors

---

Order Number	Description
M006550310	Adaptor for Storz Brand Hysteroscope 1 each 2.9mm, 12° or 30° (#23020FA or #26120BA)
M006550340	Adaptor for Wolf Brand Hysteroscope 1 each 2.7mm, 25° or 30° (#8947.401)
M006550350	Adaptor for ACMI-Circon Brand Hysteroscope 1 each 2.7mm, 12° or 30° (#G27L-12A or #G27L30WA)
M006550360	Adaptor for Olympus Brand Hysteroscope 1 each 3mm, 0°, 12° or 30° (#A4674A, #A4673A or #A4672A)







































# PRODUCT CODE INDEX

Order No.	Description	Page	Order No.	Description	Page
	(Kits) .....	13	M0063203000 .....	Leslie Parachute™ Multi-Wire Stone Sweeping Devices, "O" Tip .....	21
M0062301000 .....	Nottingham™ One-Step Tapered Dilators with HydroPlus™ Coating .....	15	M0063203010 .....	Leslie Parachute Multi-Wire Stone Sweeping Devices, 5cm Filiform Tip.....	21
M0062301010 .....	Nottingham One-Step Tapered Dilators with HydroPlus Coating .....	15	M0063203020 .....	Leslie Parachute Multi-Wire Stone Sweeping Devices, "O" Tip.....	21
M0062301100 .....	Nottingham One-Step Tapered Dilators with HydroPlus Coating .....	15	M0063203030 .....	Leslie Parachute Multi-Wire Stone Sweeping Devices, 5cm Filiform Tip.....	21
M0062301150 .....	Nottingham One-Step Tapered Dilators with HydroPlus Coating .....	15	M0063204000 .....	Graspit™ Nitinol Stone Retrieval 2-Prong Forceps.....	18
M0062401000 .....	Ureteral Dilatation Set with HydroPlus™ Coating.....	15	M0063204010 .....	Graspit Nitinol Stone Retrieval 2-Prong Forceps.....	18
M0062401100 .....	Ureteral Dilators with HydroPlus™ Coating .....	15	M0063204020 .....	Graspit Nitinol Stone Retrieval 2-Prong Forceps.....	18
M0062401110 .....	Ureteral Dilators with HydroPlus Coating .....	15	M0063204030 .....	Graspit Nitinol Stone Retrieval 2-Prong Forceps.....	18
M0062401120 .....	Ureteral Dilators with HydroPlus Coating .....	15	M0063301040 .....	Gemini™ Paired Wire Helical Basket, 3 Wire Basket, "O" Tip.....	19
M0062401130 .....	Ureteral Dilators with HydroPlus Coating .....	15	M0063301050 .....	Gemini Paired Wire Helical Basket, 3 Wire Basket, 5cm Filiform Tip.....	19
M0062401140 .....	Ureteral Dilators with HydroPlus Coating .....	15	M0063301060 .....	Gemini Paired Wire Helical Basket, 3 Wire Basket, "O" Tip.....	19
M0062401150 .....	Ureteral Dilators with HydroPlus Coating .....	15	M0063301070 .....	Gemini Paired Wire Helical Basket, 3 Wire Basket, 5cm Filiform Tip.....	19
M0062501000 .....	Ureteral Dilator with HydroPlus™ Coating and Procedural Sheath Set..	15	M0063301080 .....	Gemini Paired Wire Helical Basket, 4 Wire Basket, "O" Tip.....	19
M0062502000 .....	Navigator™ Ureteral Access Sheath Sets 11/13Fr x 28 cm.....	11	M0063301090 .....	Gemini Paired Wire Helical Basket, 4 Wire Basket, 5cm Filiform Tip.....	19
M0062502020 .....	Navigator Ureteral Access Sheath Sets 11/13Fr x 36 cm.....	11	M0063301100 .....	Gemini Paired Wire Helical Basket, 4 Wire Basket, "O" Tip.....	19
M0062502031 .....	Navigator Ureteral Access Sheath Sets 11/13Fr x 36 cm.....	11	M0063301110 .....	Gemini Paired Wire Helical Basket, 4 Wire Basket, 5cm Filiform Tip.....	19
M0062502040 .....	Navigator Ureteral Access Sheath Sets 11/13Fr x 46 cm.....	11	M0063301120 .....	Gemini Paired Wire Helical Basket, 5 Wire Basket, "O" Tip.....	19
M0062502060 .....	Navigator Ureteral Access Sheath Sets 13/15Fr x 28 cm.....	11	M0063301140 .....	Gemini Paired Wire Helical Basket, 5 Wire Basket, 5cm Filiform Tip.....	19
M0062502080 .....	Navigator Ureteral Access Sheath Sets 13/15Fr x 36 cm.....	11	M0063301150 .....	Gemini Paired Wire Helical Basket, 5 Wire Basket, "O" Tip.....	19
M0062502100 .....	Navigator Ureteral Access Sheath Sets 13/15Fr x 46 cm.....	11	M0063301160 .....	Gemini Paired Wire Helical Basket, 5 Wire Basket, 5cm Filiform Tip.....	19
M0062502210 .....	Navigator™ HD Ureteral Access Sheath 11/13Fr x 28 cm.....	11	M0063302040 .....	Gemini Paired Wire Helical Basket, 3 Wire Basket, "O" Tip.....	19
M0062502220 .....	Navigator HD Ureteral Access Sheath 11/13Fr x 36 cm.....	11	M0063302050 .....	Gemini Paired Wire Helical Basket, 3 Wire Basket, 5cm Filiform Tip.....	19
M0062502230 .....	Navigator HD Ureteral Access Sheath 11/13Fr x 46 cm.....	11	M0063302060 .....	Gemini Paired Wire Helical Basket, 3 Wire Basket, "O" Tip.....	19
M0062502240 .....	Navigator HD Ureteral Access Sheath 12/14Fr x 28 cm.....	11	M0063302080 .....	Gemini Paired Wire Helical Basket, 4 Wire Basket, "O" Tip.....	19
M0062502250 .....	Navigator HD Ureteral Access Sheath 12/14Fr x 36 cm.....	11	M0063302090 .....	Gemini Paired Wire Helical Basket, 4 Wire Basket, 5cm Filiform Tip.....	19
M0062502260 .....	Navigator HD Ureteral Access Sheath 12/14Fr x 46 cm.....	11	M0063302100 .....	Gemini Paired Wire Helical Basket, 4 Wire Basket, "O" Tip.....	19
M0062502270 .....	Navigator HD Ureteral Access Sheath 13/15Fr x 28 cm.....	11	M0063302110 .....	Gemini Paired Wire Helical Basket, 4 Wire Basket, 5cm Filiform Tip.....	19
M0062502280 .....	Navigator HD Ureteral Access Sheath 13/15Fr x 36 cm.....	11	M0063302120 .....	Gemini Paired Wire Helical Basket, 5 Wire Basket, "O" Tip.....	19
M0062502290 .....	Navigator HD Ureteral Access Sheath 13/15Fr x 46 cm.....	11	M0063302140 .....	Gemini Paired Wire Helical Basket, 5 Wire Basket, 5cm Filiform Tip.....	19
M0062601000 .....	Amplatz Type Graduated Renal Dilator Set.....	52	M0063302150 .....	Gemini Paired Wire Helical Basket, 5 Wire Basket, "O" Tip.....	19
M0062601010 .....	Amplatz Type Renal Dilators (Individual Components) .....	52	M0063303040 .....	Gemini Paired Wire Helical Basket, 3 Wire Basket, "O" Tip.....	19
M0062601020 .....	Amplatz Type Renal Dilators (Individual Components) .....	52	M0063303060 .....	Gemini Paired Wire Helical Basket, 3 Wire Basket, "O" Tip.....	19
M0062601030 .....	Amplatz Type Renal Dilators (Individual Components) .....	52	M0063303070 .....	Gemini Paired Wire Helical Basket, 3 Wire Basket, 5cm Filiform Tip.....	19
M0062601040 .....	Amplatz Type Renal Dilators (Individual Components) .....	52	M0063401210 .....	Bagley™ Helical Basket.....	20
M0062601050 .....	Amplatz Type Renal Dilators (Individual Components) .....	52	M0063401220 .....	Bagley Helical Basket.....	20
M0062601060 .....	Amplatz Type Renal Dilators (Individual Components) .....	52	M0063701000 .....	Tricep™ Hooked-Prong Grasping Forceps, 3-Prong Mini-Throw .....	20
M0062601070 .....	Amplatz Type Renal Dilators (Individual Components) .....	52	M0063701010 .....	Tricep Hooked-Prong Grasping Forceps, 3-Prong Mini-Throw .....	20
M0062601080 .....	Amplatz Type Renal Dilators (Individual Components) .....	52	M0063701100 .....	Tricep Hooked-Prong Grasping Forceps, Retracting.....	20
M0062601090 .....	Amplatz Type Renal Dilators (Individual Components) .....	52	M0063701110 .....	Tricep Hooked-Prong Grasping Forceps, Retracting.....	20
M0062601100 .....	Amplatz Type Renal Dilators (Individual Components) .....	52	M0063701140 .....	Tricep Hooked-Prong Grasping Forceps, Retracting.....	20
M0062601110 .....	Amplatz Type Renal Dilators (Individual Components) .....	52	M0063701150 .....	Tricep Hooked-Prong Grasping Forceps, Retracting.....	20
M0062601120 .....	Amplatz Type Renal Dilators (Individual Components) .....	52	M0063701180 .....	Tricep Hooked-Prong Grasping Forceps, Non-Retracting .....	20
M0062601200 .....	8/10 Dilator/Sheath Set.....	53	M0063701190 .....	Tricep Hooked-Prong Grasping Forceps, Non-Retracting .....	20
M0062601450 .....	Amplatz Type Renal Sheath (Individual Components) .....	53	M0063701220 .....	Tricep Hooked-Prong Grasping Forceps, Extra-Strength.....	20
M0062601460 .....	Amplatz Type Renal Sheath (Individual Components) .....	53	M0063701230 .....	Tricep Hooked-Prong Grasping Forceps, Extra-Strength.....	20
M0062601470 .....	Amplatz Type Renal Sheath (Individual Components) .....	53	M0063801000 .....	Segura Hemisphere™ Stone Retrieval Basket, 4 Wire Basket, "O" Tip..	20
M0062601480 .....	Amplatz Type Renal Sheath (Individual Components) .....	53	M0063801020 .....	Segura Hemisphere Stone Retrieval Basket, 4 Wire Basket, "O" Tip....	20
M0062601490 .....	Amplatz Type Renal Sheath (Individual Components) .....	53	M0063801060 .....	Segura Hemisphere Stone Retrieval Basket, 4 Wire Basket, "O" Tip....	20
M0062601500 .....	Amplatz Type Renal Sheath (Set) .....	53	M0063801070 .....	Segura Hemisphere Stone Retrieval Basket, 4 Wire Basket, "O" Tip....	20
M0062601510 .....	Amplatz Type Renal Sheath (Individual Components) .....	53	M0063801100 .....	Segura Hemisphere Stone Retrieval Basket, 4 Wire Basket, "O" Tip....	20
M0062601520 .....	Amplatz Type Renal Sheath (Individual Components) .....	53	M0063801120 .....	Segura Hemisphere Stone Retrieval Basket, 4 Wire Basket, "O" Tip....	20
M0062601530 .....	Amplatz Type Renal Sheath (Individual Components) .....	53	M0063801160 .....	Segura Hemisphere Stone Retrieval Basket, 4 Wire Basket, "O" Tip....	20
M0062601540 .....	Amplatz Type Renal Sheath (Individual Components) .....	53	M0063801180 .....	Segura Hemisphere Stone Retrieval Basket, 4 Wire Basket, "O" Tip....	20
M0062601600 .....	Clear Renal Sheath.....	52			
M0062602500 .....	Amplatz Type Renal Dilator/Sheath Set .....	52			

# PRODUCT CODE INDEX

Order No.	Description	Page	Order No.	Description	Page
M0063801190	Segura Hemisphere™ Stone Retrieval Basket, 4 Wire Basket, 5cm Filiform Tip.....	20	M0064003011	Imager II Catheters, C2 .....	44, 54
M0063901000	Zero Tip™ Nitinol 4 Wire Basket.....	18	M0064003021	Imager II Catheters, Straight .....	44, 54
M0063901010	Zero Tip 4 Nitinol Wire Basket.....	18	M0064003031	Imager II Catheters, Bern .....	44, 54
M0063901020	Zero Tip 4 Nitinol Wire Basket.....	18	M0064003041	Imager II Catheters, JB1.....	44, 54
M0063901030	Zero Tip 4 Nitinol Wire Basket.....	18	M0064004021	Imager II Catheters, Straight .....	44, 54
M0063901040	Zero Tip 4 Nitinol Wire Basket.....	18	M0064004031	Imager II Catheters, Bern .....	44, 54
M0063901050	Zero Tip 4 Nitinol Wire Basket.....	18	M0064004041	Imager II Catheters, JB1.....	44, 54
M0063902000	Escape™ Nitinol Stone Retrieval Basket .....	17	M0064005031	Imager II Catheters, Bern .....	44, 54
M0063902010	Escape Nitinol Stone Retrieval Basket .....	17	M0064051000	Dual Lumen™ Ureteral Catheter.....	44
M0063903000	OptiFlex™ Nitinol Stone Retrieval Basket.....	17	M0064101000	Malecot™ Nephrostomy Catheters.....	57
M0063903010	OptiFlex Nitinol Stone Retrieval Basket.....	17	M0064101010	Malecot Nephrostomy Catheters.....	57
M0063903100	Stone Cone™ Nitinol Urological Retrieval Coils.....	17	M0064101020	Malecot Nephrostomy Catheters.....	57
M0063903200	Stone Cone Nitinol Urological Retrieval Coils.....	17	M0064101030	Malecot Nephrostomy Catheters.....	57
M0063909000	BackStop™ Clear Gel x 3Fr Catheter .....	17	M0064101040	Re-Entry™ Malecot Nephrostomy Catheters.....	57
M0063909010	BackStop Clear Gel x 5Fr Catheter .....	17	M0064101050	Re-Entry Malecot Nephrostomy Catheters.....	57
M0063909040	BackStop Injector .....	17	M0064101060	Re-Entry Malecot Nephrostomy Catheters.....	57
M0063909050	BackStop Replacement Sleeve .....	17	M0064101070	Re-Entry Malecot Nephrostomy Catheters.....	57
M0064001161	Axxcess™ 6 French Ureteral Catheter .....	46	M0064101110	Percutaneous Nephrostomy Catheters with Locking Loop.....	59
M0064001400	C-Flex™ Flexible Tip Open End Ureteral Catheters (Sets).....	46	M0064101120	Percutaneous Nephrostomy Catheters with Locking Loop.....	59
M0064001410	C-Flex Flexible Tip Open End Ureteral Catheters (Sets).....	46	M0064101260	Percutaneous Combination Stent/Nephrostomy Catheter.....	59
M0064001500	C-Flex™ Firm Open End Ureteral Catheters (Sets) .....	46	M0064102020	Percuflex™ Locking Loop All Purpose Drainage Catheter with Fader Tip™.....	58
M0064001510	C-Flex Firm Open End Ureteral Catheters (Sets) .....	46	M0064102030	Percuflex All Purpose Drainage Catheters with Fader Tip and Locking Pigtail.....	58
M0064001520	C-Flex Firm Open End Ureteral Catheters (Sets) .....	46	M0064102040	Percuflex Locking Loop Nephrostomy Catheters with Fader Tip .....	58
M0064001530	C-Flex Firm Open End Ureteral Catheters (Sets) .....	46	M0064102050	Percuflex Locking Loop Nephrostomy Catheters with Fader Tip .....	58
M0064001610	C-Flex™ Firm Stamey Open Tip Ureteral Catheters (Sets).....	47	M0064102060	Percuflex Locking Loop Nephrostomy Catheters with Fader Tip .....	58
M0064001620	C-Flex Firm Stamey Open Tip Ureteral Catheters (Sets).....	47	M0064103040	Percuflex Locking Loop Nephrostomy Catheters with Fader Tip (Kits).....	59
M0064001630	C-Flex Firm Stamey Open Tip Ureteral Catheters (Sets).....	47	M0064103050	Percuflex Locking Loop Nephrostomy Catheters with Fader Tip (Kits).....	59
M0064001640	C-Flex Firm Stamey Open Tip Ureteral Catheters (Sets).....	47	M0064201100	Percutaneous Access Set (without Balloon or Amplatzer Dilators).....	49
M0064001700	C-Flex™ Ureteral Pigtail Catheters.....	47	M0064201110	Percutaneous Nephrostomy Sets – Pigtail Design.....	49, 60
M0064001710	C-Flex Ureteral Pigtail Catheters.....	47	M0064201120	Percutaneous Nephrostomy Sets – Pigtail Design.....	49, 60
M0064001720	C-Flex Ureteral Pigtail Catheters.....	47	M0064201150	Percutaneous Nephrostomy Catheter Set – Malecot Design.....	49, 60
M0064001730	C-Flex Ureteral Pigtail Catheters.....	47	M0064202000	Jinro™ Percutaneous Nephrostomy Sets – Flexima™ Catheter Pigtail Design .....	50
M0064002001	Flexima™ Ureteral Catheters, Open End .....	45	M0064202020	Jinro Percutaneous Nephrostomy Sets – Pigtail Design .....	50
M0064002011	Flexima Ureteral Catheters, Open End .....	45	M0064202040	Jinro Percutaneous Nephrostomy Sets – Pigtail Design .....	50
M0064002021	Flexima Ureteral Catheters, Open End .....	45	M0064202060	Jinro Percutaneous Nephrostomy Sets – Replacement Kits .....	50
M0064002031	Flexima Ureteral Catheters, Open End .....	45	M0064202080	Jinro Percutaneous Nephrostomy Sets – Replacement Kits .....	50
M0064002041	Flexima Ureteral Catheters, Open End .....	45	M0064501140	Percutaneous Tract Kit with NephroMax High Pressure Balloon Dilatation Catheter .....	49
M0064002111	Flexima Ureteral Catheters, Cone Tip.....	45	M0064501150	Lingeman Percutaneous Tract Kit with NephroMax High Pressure Nephrostomy Balloon Dilatation Catheter .....	49
M0064002121	Flexima Ureteral Catheters, Cone Tip.....	45	M0065051600	Piranha™ 3Fr/1.0mm Ureteroscopic Biopsy Forceps.....	63
M0064002131	Flexima Ureteral Catheters, Cone Tip.....	45	M006550310	Adaptor for Storz Brand Hysteroscope 1 each.....	75
M0064002141	Flexima Ureteral Catheters, Cone Tip.....	45	M006550340	Adaptor for Wolf Brand Hysteroscope 1 each .....	75
M0064002201	Flexima Ureteral Catheters, Whistle Tip.....	45	M006550350	Adaptor for ACMI-Circon Brand Hysteroscope 1 each.....	75
M0064002211	Flexima Ureteral Catheters, Whistle Tip.....	45	M006550360	Adaptor for Olympus Brand Hysteroscope 1 each .....	75
M0064002221	Flexima Ureteral Catheters, Whistle Tip.....	45	M006580020	Genesys HTA™ 230V Control Unit - English 1 each.....	75
M0064002301	Flexima Ureteral Catheters, Olive Tip .....	45	M006580040	Genesys HTA Pedestal 1 each.....	75
M0064002311	Flexima Ureteral Catheters, Olive Tip .....	45	M006580201	Genesys HTA™ ProCerva™ Procedure Set Box of 5.....	75
M0064002361	Flexima Ureteral Catheters, Spiral Tip.....	45	M006582110	Genesys HTA 230V Control Unit - Danish 1 each.....	75
M0064002371	Flexima Ureteral Catheters, Spiral Tip.....	45	M006582210	Genesys HTA 230V Control Unit - Swedish 1 each.....	75
M0064002411	Flexima Ureteral Catheters, Wedge Tip.....	45	M006582310	Genesys HTA 230V Control Unit - French 1 each.....	75
M0064002510	Flexima Ureteral Catheters (Sets with .035" PTFE Bentson Tip Guidewire), Angled Tip Set.....	45	M006582410	Genesys HTA 230V Control Unit - Italian 1 each .....	75
M0064002520	Flexima Ureteral Catheters (Sets with .035" PTFE Bentson Tip Guidewire), Angled Tip Set.....	45	M0066001020	Standard Lubriglide™ Coated Guidewires (Fixed Core,	
M0064003001	Imager™ II Catheters, C1 .....	44, 54			

# PRODUCT CODE INDEX

Order No.	Description	Page	Order No.	Description	Page
	Stiff Bodied) Straight .....	7	M0067301401	UroLok™ II Scope with Ball-fitting Adaptor.....	69
M0066001030	Standard Lubriglide™ Coated Guidewires (Moveable Core) Straight.....	7	M0067301501	Gateway™ Advantage Y Adaptor.....	69
M0066001050	Standard Lubriglide™ Coated Guidewires (Fixed Core) Straight .....	7	M0067401000	30cm Connecting Tube for 3 through 6Fr Catheters .....	69
M0066001060	Standard Lubriglide Coated Guidewires (Fixed Core) Straight .....	7	M0067401010	30cm Connecting Tube for 7 through 10Fr Catheters .....	69
M0066001200	Standard Lubriglide Coated Guidewires (Fixed Core) Straight .....	7	M0067401020	30cm “Y” Connecting Tube for Two 3 through 6Fr Catheters.....	69
M0066001250	Standard Lubriglide Coated Guidewires (Fixed Core) Straight .....	7	M0067401100	Connection for 3 through 6Fr Catheters with Luer Lock Fitting.....	69
M0066001300	Standard Lubriglide Coated Guidewires (Moveable Core) Straight.....	7	M0067401110	Connection for 7 through 10Fr Catheters with Luer Lock Fitting .....	69
M0066201000	PTFE Coated Guidewires (Fixed Core) Straight .....	6	M0067401200	Connection for Female Luer Lock Fitting to Drainage Bag.....	69
M0066201010	PTFE Coated Guidewires (Fixed Core, Stiff Bodied) Straight.....	6	M0067401220	Connection for 3 through 6Fr Ureteral Catheters to Drainage Bag .....	69
M0066201020	PTFE Coated Guidewires (Fixed Core, Stiff Bodied) .....	6	M0068302410	Xenform™ Soft Tissue Repair Matrix.....	74
M0066201030	PTFE Coated Guidewires (Moveable Core) Straight.....	7	M0068302430	Xenform Soft Tissue Repair Matrix.....	74
M0066201050	PTFE Coated Guidewires (Fixed Core) Straight .....	6	M0068302450	Xenform Soft Tissue Repair Matrix.....	74
M0066201070	PTFE Coated Guidewires (Fixed Core) Straight .....	6	M0068302470	Xenform Soft Tissue Repair Matrix.....	74
M0066201080	PTFE Coated Guidewires (Fixed Core, Stiff Bodied) Straight.....	6	M0068312321	Capio Suture Capturing Devices – Standard .....	73
M0066201100	PTFE Coated Guidewires (Fixed Core, Stiff Bodied) Straight.....	6	M0068318150	Pinnacle Lite Posterior.....	74
M0066201110	PTFE Coated Guidewires (Fixed Core, Stiff Bodied) .....	6	M0068318170	Uphold™ Lite Vaginal Support System .....	74
M0066201200	PTFE Coated Guidewires (Fixed Core) Straight .....	6	M0068318250	Capio™ SLIM Suture Capturing Device (1/bx) .....	73
M0066201210	PTFE Coated Guidewires (Moveable Core) 3mm “J” .....	7	M0068318262	Capio SLIM Suture Capturing Device (5/bx) .....	73
M0066201220	PTFE Coated Guidewires (Moveable Core) 3mm “J” .....	7	M0068318220	Upsilon Y-Mesh and Colpassist Vaginal Positioning Device Kit .....	74
M0066201250	PTFE Coated Guidewires (Fixed Core) Straight .....	6	M0068321010	Capio™ RP Suture capturing device for an open radical prostatectomy.....	63
M0066201300	PTFE Coated Guidewires (Moveable Core) Straight.....	7	M0068331131	Capio™ Sutures.....	73
M0066401041	Amplatz Super Stiff™ PTFE Coated Guidewires Straight.....	7	M0068331141	Capio Sutures.....	73
M0066401051	Amplatz Super Stiff PTFE Coated Guidewires 3mm “J” .....	7	M0068331231	Capio Sutures.....	73
M0066401061	Amplatz Super Stiff PTFE Coated Guidewires Straight.....	7	M0068331241	Capio Sutures.....	73
M0066401071	Amplatz Super Stiff PTFE Coated Guidewires 3mm “J” .....	7	M0068331351	Absorbable, Monofilament POLYGLYTON™ Suture.....	63
M0066401081	Amplatz Super Stiff PTFE Coated Guidewires Straight.....	7	M0068331361	Absorbable, Braided Coated PGA Suture .....	63
M0066401091	Amplatz Super Stiff PTFE Coated Guidewires Straight.....	7	M0068331371	Capio Sutures.....	73
M0066701081	Zebra™ Urological Guidewires Straight .....	6	M0068332131	Capio Sutures.....	73
M0066701091	Zebra Urological Guidewires Angled.....	6	M0068402400	Polyform™ Synthetic Mesh .....	74
M0066701101	Zebra Urological Guidewires Straight .....	6	M0068402401	Polyform Synthetic Mesh (5/bx) .....	74
M0066701121	Zebra Urological Guidewires Straight .....	6	M0068402410	Polyform Synthetic Mesh .....	74
M0066701131	Zebra Urological Guidewires Angled.....	6	M0068403910	Flexiva™ 200 High Power Single-Use Laser Fiber .....	16
M0066701141	Zebra Urological Guidewires Straight .....	6	M0068403911	Flexiva 200 High Power Single-Use Laser Fiber (5/bx) .....	16
M0066701151	Zebra Urological Guidewires Angled.....	6	M0068403920	Flexiva 365 High Power Single-Use Laser Fiber .....	16
M0066703011	Sensor™ Dual-Flex PTFE-Nitinol Guidewires with Hydrophilic Tip (10cm Flexible Proximal End) Angled.....	5	M0068403921	Flexiva 365 High Power Single-Use Laser Fiber (5/bx) .....	16
M0066703021	Sensor Dual-Flex PTFE-Nitinol Guidewires with Hydrophilic Tip (10cm Flexible Proximal End) Angled.....	5	M0068403930	Flexiva 550 High Power Single-Use Laser Fiber .....	16
M0066703051	Sensor™ PTFE-Nitinol Guidewires with Hydrophilic Tip Straight.....	5	M0068403931	Flexiva 550 High Power Single-Use Laser Fiber(5/bx) .....	16
M0066703061	Sensor PTFE-Nitinol Guidewires with Hydrophilic Tip Angled .....	5	M0068403940	Flexiva 1000 High Power Single-Use Laser Fiber .....	16
M0066703081	Sensor Dual-Flex PTFE-Nitinol Guidewires with Hydrophilic Tip (10cm Flexible Proximal End) Straight .....	5	M0068403941	Flexiva 1000 High Power Single-Use Laser Fiber (5/bx).....	16
M0066703091	Sensor PTFE-Nitinol Guidewires with Hydrophilic Tip Straight .....	5	M0068403960	Flexiva™ TracTip 200 High Power Single-Use Laser Fiber .....	16
M0066703101	Sensor PTFE-Nitinol Guidewires with Hydrophilic Tip Angled .....	5	M0068403961	Flexiva TracTip 200 High Power Single-Use Laser Fiber (5/bx) .....	16
M0066703121	Sensor Dual-Flex PTFE-Nitinol Guidewires with Hydrophilic Tip (10cm Flexible Proximal End) Straight .....	5	M0068404010	AccuMax™ 200 Single-Use Holmium Laser Fiber .....	16
M0067001200	Access Needles.....	56	M0068404012	AccuMax 200 Single-Use Holmium Laser Fiber (5/bx).....	16
M0067001210	Access Needles.....	56	M0068404020	AccuMax 365 Single-Use Holmium Laser Fiber.....	16
M0067001220	Access Needles.....	56	M0068404022	AccuMax 365 Single-Use Holmium Laser Fiber (5/bx).....	16
M0067001230	Access Needles.....	56	M0068404030	AccuMax 550 Single-Use Holmium Laser Fiber.....	16
M0067101131	Encore™ 26 Inflator with Pressure Gauge.....	14, 51, 67	M0068404032	AccuMax 550 Single-Use Holmium Laser Fiber (5/bx).....	16
M0067101140	Encore 26 Inflator with Pressure Gauge.....	14, 51, 67	M0068404040	AccuMax 1000 Single-Use Holmium Laser Fiber.....	16
M0067201001	SAPS™ Single Action Pumping System.....	68	M0068404042	AccuMax 1000 Single-Use Holmium Laser Fiber (5/bx).....	16
M0067201011	SAPS™ CF Continuous Flow Single Action Pumping System .....	68	M0068404120	LithoCatch™ Immobilization Device, “O” Tip.....	21
M0067301251	Urovac™ Bladder Evacuator with Adaptor.....	67	M0068404110	AccuTrac™ 200 Single-Use Holmium Laser Fiber .....	16
M0067301301	Guidewire Torque Vise Steerable Handle.....	8	M0068404112	AccuTrac 200 Single-Use Holmium Laser Fiber (5/bx) .....	16
			M0068502000	Advantage™ System (Transvaginal) .....	71
			M006850200051	Advantage System (Transvaginal) (5/bx) .....	71



## PRODUCT CODE INDEX

Order No.	Description	Page
M0068502110	Advantage Fit™ System (single unit)	71
M0068502111	Advantage Fit System (5/bx)	71
M0068503000	Lynx™ System (Suprapubic) (single unit)	71
M0068503001	Lynx System (Suprapubic) (5/bx)	71
M0068504000	Obtryx™ System Curved (single unit)	72
M0068504001	Obtryx System Curved (5/bx)	72
M0068505000	Obtryx System Halo (single unit)	72
M0068505001	Obtryx System Halo (5/bx)	72
M0068504110	Obtryx™ II Transobturator Mid-Urethral Sling System - Curved (1/bx)	72
M0068504111	Obtryx II Transobturator Mid-Urethral Sling System - Curved (5/bx)	72
M0068505110	Obtryx II Transobturator Mid-Urethral Sling System - Halo (1/bx)	72
M0068505111	Obtryx II Transobturator Mid-Urethral Sling System - Halo (5/bx)	72
M0068507000	Solyx™ SIS System (single unit)	72
M0068507001	Solyx SIS System (5/bx)	72
M0068802011	Powerball™ Electrode (5/bx)	65
M0068802031	Cutting Loop (10/bx)	65
M0068802041	Cutting Loop (10/bx)	65
M0068802051	3mm Rollerball Electrode (10/bx)	65
M0068802061	3mm Rollerball Electrode (10/bx)	65
M0068802071	TUIP Knife (10/bx)	65
M0068802211	Powerball Electrode (5/bx)	65
M0068802231	Cutting Loop (10/bx)	65
M0068802241	Cutting Loop (10/bx)	65
M0068802251	3mm Rollerball Electrode (10/bx)	65
M0068802271	TUIP Knife (10/bx)	65
M0068802311	Powerball Electrode (5/bx)	65
M0068802331	Cutting Loop (10/bx)	65
M0068802341	Cutting Loop (10/bx)	65
M0068802351	3mm Rollerball Electrode (10/bx)	65
M0068802361	3mm Rollerball Electrode (10/bx)	65
M0068802371	TUIP Knife (10/bx)	65
M0068802411	Powerball Electrode (5/bx)	65
M0068802431	Cutting Loop (10/bx)	65
M0068802451	3mm Rollerball Electrode (10/bx)	65
M0068802471	TUIP Knife (10/bx)	65
M0068802611	Cutting Loop (10/bx)	65
M0068802621	Cutting Loop (10/bx)	65
M0068802641	3mm Rollerball (10/bx)	65
M0068802651	5mm Rollerball (10/bx)	65
M0068802671	TUIP Knife (10/bx)	65
M0068802681	Incision Blade (10/bx)	65
M0069001230	Amplatz Type Renal Sheath (Individual Components)	53



# Product Index

8/10 Dilator/Sheath Set.....	53	Contour VL™ Injection Variable Length Stents with HydroPlus™ Coating and Injection Positioner – a Percuflex™ Material Stent.....	39	Nephromax™ High Pressure Nephrostomy Balloon Catheter .....	51
Access Needles.....	56	Contour VL™ Variable Length Percuflex™ Stents with HydroPlus™ Coating.....	36, 37	Nephromax High Pressure Nephrostomy Balloon Catheter (Kit).....	51
AccuMax™ Single-Use Holmium Laser Fiber .....	16	Contour™ Injection Stents with HydroPlus™ Coating and Injection Positioner – a Percuflex™ Material Stent .....	38, 39	Nottingham™ One-Step Tapered Dilators with HydroPlus™ Coating.....	15
AccuTrac™ Single-Use Holmium Laser Fiber .....	16	Contour™ Stents with HydroPlus™ Coating – a Softer Percuflex Material Stent .....	30, 31	Obtryx™ System (Transobturator).....	72
Advantage™ System (Transvaginal).....	71	Contour™ Stents with HydroPlus™ Coating (with Braided Retrieval Line) .....	32	Occluder™ Occlusion Balloon Catheters.....	55
Advantage Fit™ System (Transvaginal).....	71	Drainage Bag Connectors.....	69	OptiFlex™ Nitinol Stone Retrieval Basket.....	17
Amplatz Super Stiff™ PTFE Coated Guidewires .....	7	Dual Lumen™ Ureteral Catheter .....	44	Passport™ Balloon Dilatation Catheters .....	14
Amplatz Type Graduated Renal Dilator Set .....	52	Encore™ 26 Inflator .....	14, 51, 67	Passport™ Balloon Dilatation Catheters (Kits) .....	14
Amplatz Type Renal Dilators (Individual Components).....	52	Escape™ Nitinol Stone Retrieval Basket .....	17	Percuflex™ All Purpose Drainage Catheters with Fader Tip™ and Locking Pigtail .....	58
Amplatz Type Renal Dilator/Sheath Set .....	52	Flexima™ Ureteral Catheters .....	45	Percuflex™ Combination Stent/Nephrostomy Catheters.....	59
Amplatz Type Renal Sheath (Individual Components).....	53	Flexima Ureteral Catheters (Sets with .035“ PTFE Bentson Tip Guidewire) ...	45	Percuflex™ Locking Loop Nephrostomy Catheters... ..	59
Amplatz Type Renal Sheath (Set).....	53	Flexiva™ High Power Single-Use Laser Fiber .....	16	Percuflex™ Locking Loop Nephrostomy Catheters with Fader Tip.....	58
Axxcess™ 6 French Ureteral Catheter .....	46	Flexiva™ TracTip High Power Single-Use Laser Fiber .....	16	Percuflex™ Locking Loop Nephrostomy Catheters with Fader Tip (Kits) .....	59
BackStop™ Stone Antiretropulsion Device.....	17	Gateway™ Advantage Y Adaptor.....	69	Percuflex Plus™ Stents with HydroPlus™ Coating (with Braided Retrieval Line) .....	29
Bagley™ Helical Baskets .....	20	Gemini™ Paired Wire Helical Baskets.....	19	Percuflex Plus™ Stents with HydroPlus™ Coating.....	27, 28
Capio™ RP Suturing Device for Radical Prostatectomy.....	63	Graspit™ Nitinol Stone Retrieval Forceps .....	18	Percuflex™ Ureteral Stents.....	33, 34
Capio™ Sutures .....	73	Guidewire Torque Vise.....	8	Percuflex™ Urinary Diversion Stents – Closed Tip Configuration (Sets with PTFE Coated Guidewire) .....	42
Capio™ Suture Capturing Devices.....	73	Imager™ II Catheters.....	44, 54	Percuflex™ Urinary Diversion Stents – Open Tip Configuration (Sets with PTFE Coated Guidewire) .....	41
C-Flex™ Firm Open End Ureteral Catheters (Sets) ..	46	Jinro™ Percutaneous Nephrostomy Sets Pigtail Design.....	50	Percutaneous Access Set (without Balloon or Amplatz Dilators) .....	49
C-Flex™ Firm Stamey Open Tip Ureteral Catheters (Sets) .....	47	Flexima™ Catheter Pigtail Design.....	50	Percutaneous Nephrostomy Catheter Set – Malecot Design.....	49, 60
C-Flex™ Flexible Tip Open End Ureteral Catheters (Sets) .....	46	Replacement (Kits) .....	50	Percutaneous Nephrostomy Sets – Pigtail Design .....	50, 60
C-Flex™ Ureteral Pigtail Catheters.....	47	Leslie Parachute™ Multi-Wire Stone Sweeping Devices .....	21	Percutaneous Tract Kit with NephroMax High Pressure Balloon Dilatation Catheter.....	49
Clear Renal Sheath.....	52	Lingeman Percutaneous Tract Kit with Nephromax™ High Pressure Nephrostomy Balloon Dilatation Catheter .....	49	Pinnacle™ Pelvic Floor Repair Kits .....	74
Compatible for use with Olympus Brand OES™ Resectoscope.....	65	Lithocatch™ Immobilization Device.....	21	Piranha™ 3Fr/1.0mm Ureteroscopic.....	63
Compatible for use with Olympus Brand OES-Pro™ Series Resectoscope.....	65	Lynx™ System (Suprapubic).....	71	Polaris™ Loop Dual Durometer Ureteral Stents	
Compatible for use with Storz Brand Double Stem Resectoscope.....	65	Malecot™ Nephrostomy Catheters .....	57		
Compatible for use with Storz Brand Single Stem Resectoscope.....	65	Mardis™ Soft Stents with HydroPlus™ Coating.....	35		
Compatible for use with Wolf Brand Resectoscope .....	65	Navigator™ Ureteral Access Sheath Sets .....	11		
Connecting Tubes for Drainage Bag.....	69				

with Percufflex™ Material and HydroPlus™ Coating .....	23, 24	Ureteral Dilators with HydroPlus™ Coating .....	15
Polaris™ Ultra Dual Durometer Ureteral Stents with Percufflex™ Material and HydroPlus™ Coating .....	25, 26	Ureteral Stent Positioner .....	42
Polyform™ Synthetic Mesh .....	74	UroLok™ II Scope Adaptor .....	69
Procedure Sets .....	75	UroMax™ Ultra Balloon Dilatation Catheters (Kits) .....	13
PTFE Coated Guidewires (Fixed Core) .....	6	UroMax Ultra™ Balloon Dilatation Catheters .....	13
PTFE Coated Guidewires (Fixed Core, Stiff Bodied) .....	6	Urovac™ Bladder Evacuator .....	67
PTFE Coated Guidewires (Moveable Core) .....	7	Xenform™ Soft Tissue Repair Matrix .....	74
Re-Entry™ Malecot Nephrostomy Catheters .....	57	Zebra™ Urological Guidewires .....	6
Retromax™ Plus (Endopyelotomy Stents with HydroPlus™ Coating) .....	41	Zero Tip™ Nitinol Stone Retrieval Baskets .....	18
SAPS™ CF Continuous Flow Single Action Pumping System .....	68	ZIPwire™ Hydrophilic Guidewire .....	5
SAPS™ Single Action Pumping System .....	68		
Scope Adaptors .....	75		
Segura Hemisphere™ Stone Retrieval Baskets .....	20		
Sensor™ Dual-Flex PTFE-Nitinol Guidewires with Hydrophilic Tip (10cm Flexible Proximal End) .....	5		
Sensor™ PTFE-Nitinol Guidewires with Hydrophilic Tip .....	5		
Solyx™ SIS System .....	72		
Standard Lubriglide™ Coated Guidewires (Fixed Core) .....	7		
Standard Lubriglide™ Coated Guidewires (Fixed Core, Stiff Bodied) .....	7		
Standard Lubriglide™ Coated Guidewires (Moveable Core) .....	7		
Stone Cone™ Nitinol Urological Retrieval Coils .....	17		
Stretch™ VL Flexima™ Ureteral Stent Set (with HydroPlus™ Coating) .....	40		
Tricep™ Hooked-Prong Grasping Forceps .....	20		
Uphold™ Vaginal Support System .....	74		
Upsilon™ Y-Mesh and Colpassist™ Vaginal Positioning Device .....	74		
Ureteral Catheter Connectors .....	69		
Ureteral Dilatation Set with HydroPlus™ Coating .....	15		
Ureteral Dilator with HydroPlus™ Coating and Procedural Sheath Set .....	15		

**Boston  
Scientific**  
Advancing science for life™

[www.bostonscientific.com](http://www.bostonscientific.com)  
[www.bostonscientificstone.com](http://www.bostonscientificstone.com)  
[www.pelvic-floor-institute.com](http://www.pelvic-floor-institute.com)

Boston Scientific International SA  
Parc Val Saint Quentin - Bâtiment H  
78960 Voisins-le-Bretonneux – France  
+33 1 39 30 97 00

C-Flex is a trademark of Cook Urological.  
Stone Cone is a trademark of MedSource Technologies, LLC.

All cited trademarks are the property of their respective owners. CAUTION: The law restricts these devices to sale by or on the order of a physician. Indications, contraindications, warnings and instructions for use can be found in the product labelling supplied with each device. Information for the use only in countries with applicable health authority product registrations.

URO-217505-AA-January 2014 Printed in Germany by medicalvision.

© 2014 Boston Scientific Corporation  
or its affiliates. All rights reserved.  
DINURO2175EA